

ALPINE

SERVICE MANUAL

FM/MW/LW/RDS CD Receiver

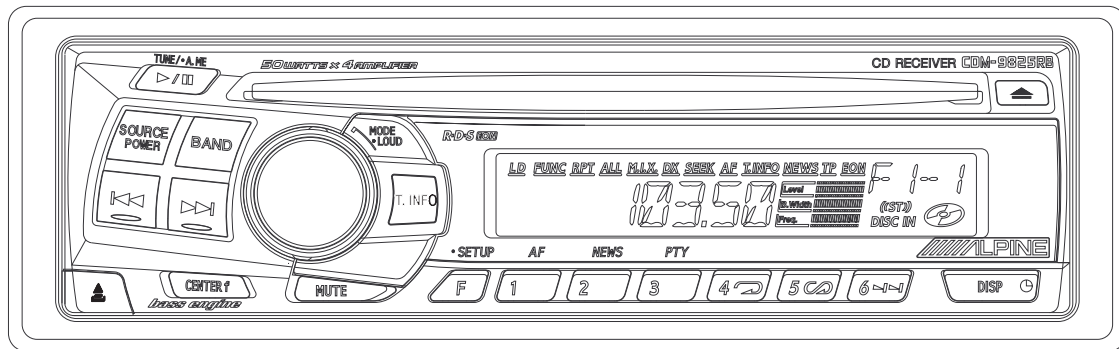

11 / 03-A
68E36125S01



CDM-9825RB

<Cautions for Safe Repair Work>



The following cautions will prevent accidents in the workplace and will ensure safe products.

*The symbols indicate caution is needed to prevent injuries and damage to property.



The symbols and their meanings follow.

 Warning	If you ignore this symbol and handle the product incorrectly or unsafely, serious injury or death may result.
 Caution	If you ignore this symbol and handle the product incorrectly or unsafely, injury or only material damage may result.



*The following symbols indicate two levels of cautions.



 When you see this symbol, you have to be very careful.	
 When you see this symbol, you have to follow the instructions there.	



Warning

 Do not look squarely into the laser light coming from the pickup. You may lose your sight.	 Fuse Caution Always use a designated fuse. Use of an incorrect fuse may result in a fire.
--	--

Caution

 Do not allow wiring to be caught in the screw/chassis. If wiring is caught in the screw/chassis, it may cause a short circuit, resulting in a fire.	 Battery Caution Use the designated battery. Confirm the correct polarity and seat of the battery. An incorrect battery or an improperly connected or seated battery may result in a fire.
---	---

 High Temperature Caution Touching the heat sink may cause severe burns.	 Designated Parts Caution Look up the part list and ensure that only designated parts are used to prevent problems or accidents.
---	---

 Reverse Power Supply Connections or Misconnections Caution Reverse power supply connections or misconnections may cause ignition problems and smoke may result.	 Wiring Caution Ensure that the wiring is correct when rewiring to prevent problems with ignition/breakdown.
---	---

 Soldering Caution Hot solder from solder splash may cause severe burns.	 Wear Gloves Wear gloves to prevent electrical shocks or injury from the end face of the metal.
---	--

Packing Assembly Parts List

Symbol No.	Part No.	Description
101-1	03S60820Y16	SCR,MCH 5X8 ZN A
101-2	36A02449K01	CAP,RUBBER(A)
101-3	01T04296K01	ISO/JA SO ANT ADAPTER
101-4	03A60836Y01	SCR,CUS 5X7 ZN A

Symbol No.	Part No.	Description
102	15D00529K02	CASE,INNER
103	15D01798K03	CARRYING,CASE
104	01T75373Y02	ASSY,ISO CONN 9825R
105	68P02294K90	O/M AOEJ AODN

Packing Method View

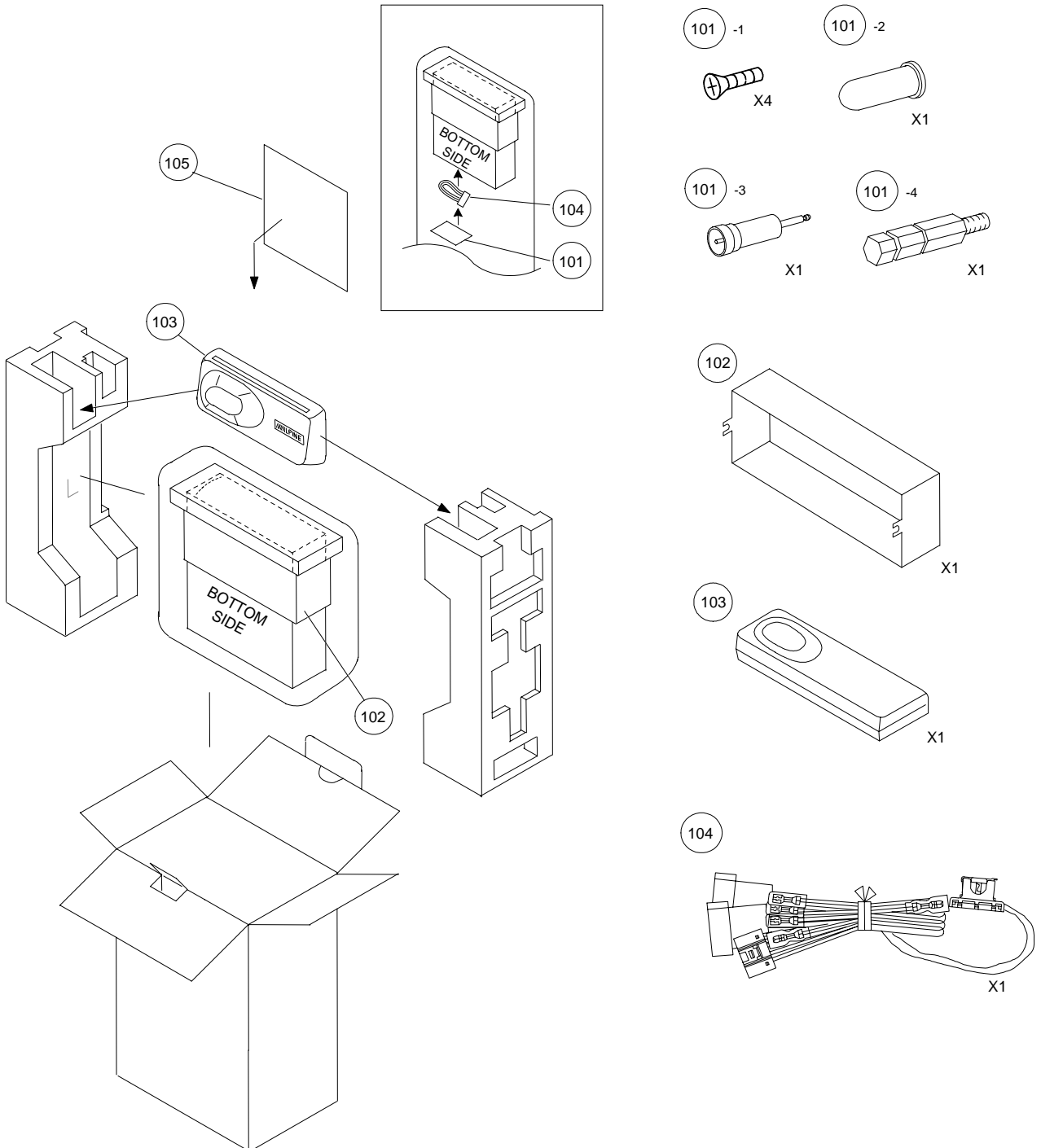

Specifications

<FM RADIO>

Intermediate Frequency	10.7MHz
Frequency Range	87.5 to 108.0MHz
Usable Sensitivity (30 S/N, Mono, at 98.1MHz)	20.2dBf
-3dB Limiting Sensitivity (at 98.1MHz)	20.2dBf
Residual Noise (Ref. 400Hz(WID), at 98.1MHz)	25±10dB
S/N Ratio (at 98.1MHz)	Stereo : 50dB Mono : 55dB
Image Rejection (at 106.1MHz)	40dB
IF Rejection (at 90.1MHz)	60dB
Distortion (Input 60dBu, at 98.1MHz)	1.0%
Frequency Response (Ref. 400Hz, at 98.1MHz)	100Hz : 0±3dB 10kHz : -12±3dB
Stereo Separation (1kHz, at 98.1MHz)	20dB
PS Sensitivity (at 98.1MHz)	36.2dBf

<MW RADIO>

Intermediate Frequency	1st : 10.7MHz 2nd : 450kHz
Frequency Range	531 to 1,602kHz
Usable Sensitivity (20dB S/N, at 999kHz)	34dB
S/N Ratio (at 999kHz)	44dB
Image Rejection (at 603kHz)	40dB
IF Rejection (at 603kHz)	50dB
Distortion (at 999kHz)	1.5%
Frequency Response (Ref. 400Hz, at 999kHz)	100Hz : -3±4dB 4kHz : -12+4, -8dB

<LW RADIO>

Intermediate Frequency	1st : 10.7MHz 2nd : 450kHz
Frequency Range	153 to 281kHz
Usable Sensitivity (20dB S/N, at 216kHz)	38dB
S/N Ratio (at 216kHz)	45dB
Image Rejection (at 270kHz)	40dB
IF Rejection (at 162kHz)	50dB
Distortion (at 216kHz)	1.5%
Frequency Response (Ref. 400Hz, at 216kHz)	100Hz : -3±4dB 4kHz : -12+4, -8dB

<Pickup>

Wave Length	795nm
Laser Power	CLASS I

CDM-9825RB

<CD SECTION>

System	Optical (Compact Disc System)
Channel Balance (1kHz, TCD-782)	0±3dB
Distortion (1kHz, TCD-782)	0.1%
Frequency Response (Ref. 1kHz, TCD-782)	17Hz : 0±3dB 127Hz : 0±2dB 10.007kHz : 0±2dB 19.997kHz : 0±4dB
S/N Ratio (TCD-782)	95dB
Separation (1kHz, TCD-782)	55dB
De-Emphasis (Ref. 1kHz, TCD-782)	4kHz : -20±3dB 16kHz : -20±3dB

<GENERAL>

Power Supply	DC14.4V
Power Output (Ref. FM Mode, SP-OUT, T.H.D. 10%) /Impedance	16W/ch/4ohm
Pre Output (Ref. TCD-782(1KHz, 0dB), T.H.D. 1%) /Impedance	FRONT/REAR : 2V±2.5dBV/ch/10kohm SUB-W(STEP+15) : 2V±2.5dBV/ch/10kohm
Dimensions (W x H x D)	Chassis : 178 x 50 x 160mm Nose : 188 x 58 x 27mm
Weight	1.5kg

NOTE : Due to Continuing product improvement, specifications and designs are subject to change without notice.

Adjustment Procedures

1. FM/MW/LW SECTION

(1) Dummy Antenna Circuit

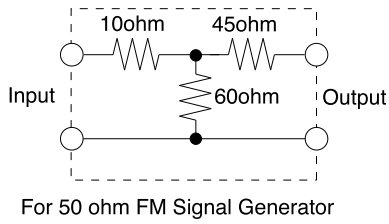

Figure 1

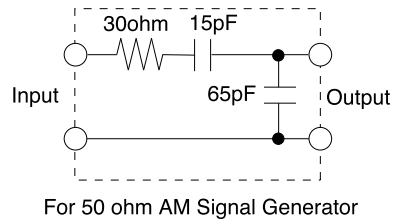
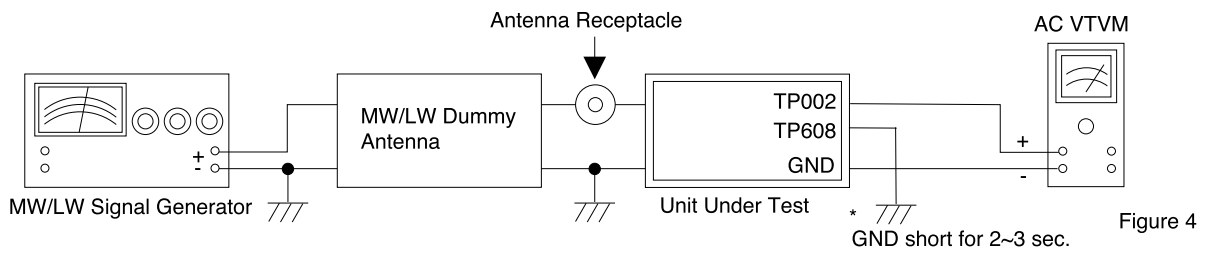
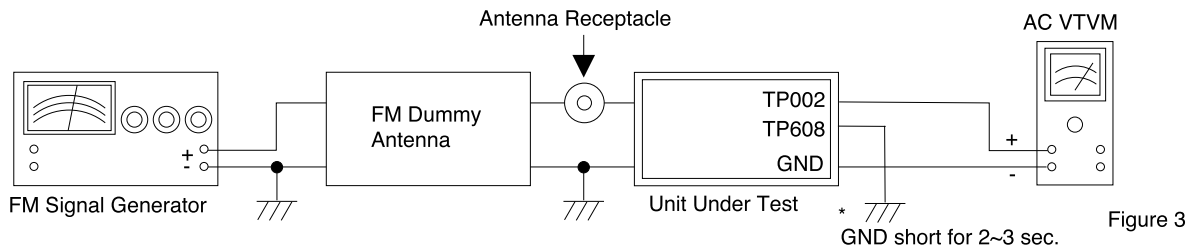

Figure 2

(2) Connections



(3) Control Settings

Power Switch ON	Band Switch FM/MW/LW
Fader Control Center Position	LOUD OFF
Balance Control Center Position	SUB-W OFF
Treble Control Center Position	Others OFF
Bass Control Center Position		

(4) Adjustment Procedures

Step	Description	Connection	Signal Generator	Dial Control	Test Point/ P.W.Board Coordinates	Adjustment
1	Signal Meter Auto Adjustment (FM)	Figure 3	(1) 87.5MHz, 26dB μ (Mod. OFF)	87.5MHz	TP002 (3-F) TP608 (5-D)	Auto Adjustment: After setting up of Signal Generator, short GND and TP608 (Pull-Down) for 2~3 seconds.
			(2) 87.5MHz, 26dB μ (Mod. OFF)	87.5MHz	TP002 (3-F) TP608 (5-D)	Proceeds same Auto Adjustment of step (1) under step (2). (SPEC) TP002: 1.5 \pm 0.1V: OK (SPEC) TP002: others 1.5 \pm 0.1V: NG NOTE : NG : Proceeds same Auto Adjustment of step (1) under step (3).
			(3) 87.5MHz, 21~23dB μ (Mod. OFF)	87.5MHz	TP002 (3-F) TP608 (5-D)	Proceeds same Auto Adjustment of step (1) under step (3).
			(4) 87.5MHz, 26dB μ (Mod. OFF)	87.5MHz	TP002 (3-F) TP608 (5-D)	Proceeds same Auto Adjustment of step (1) under step (4).
2	Signal Meter Auto Adjustment (MW)	Figure 4	(1) 999kHz, 34dB μ (Mod. OFF)	999kHz	TP002 (3-F) TP608 (5-D)	Auto Adjustment: After setting up of Signal Generator, short GND and TP608 (Pull-Down) for 2~3 seconds.
			(2) 999kHz, 34dB μ (Mod. OFF)	999kHz	TP002 (3-F) TP608 (5-D)	Proceeds same Auto Adjustment of step (1) under step (2). (SPEC) TP002: 1.0 \pm 0.1V: OK (SPEC) TP002: others 1.0 \pm 0.1V: NG NOTE : NG : Proceeds same Auto Adjustment of step (1) under step (3).
			(3) 999kHz, 29~31dB μ (Mod. OFF)	999kHz	TP002 (3-F) TP608 (5-D)	Proceeds same Auto Adjustment of step (1) under step (3).
			(4) 999kHz, 34dB μ (Mod. OFF)	999kHz	TP002 (3-F) TP608 (5-D)	Proceeds same Auto Adjustment of step (1) under step (4).

Step	Description	Connection	SignalGenerator	Dial Contro	Test Point/ P.W.Board Coordinates	Adjustment	
3	Signal Meter Auto Adjustment (LW)	Figure 4	(1)	216kHz, 34dB μ (Mod. OFF)	216kHz	TP002 (3-F) TP608 (5-D)	AutoAdjustment: After setting up of Signal Genarator, short GND and TP608(Pull-Down) for 2~3 seconds.
			(2)	216kHz, 34dB μ (Mod. OFF)	216kHz	TP002 (3-F) TP608 (5-D)	Proceedsame AutoAdjustmentof step (1) understep(2). (SPEC) TP002: 1.0 \pm 0.1V: OK (SPEC) TP002: others 1.0 \pm 0.1V: NG NOTE : NG : Proceedsame Auto Adjustmentof step(1) understep(3).
			(3)	216kHz, 29~31dB μ (Mod. OFF)	216kHz	TP002 (3-F) TP608 (5-D)	Proceedsame AutoAdjustmentof step (1) understep(3).
			(4)	216kHz, 34dB μ (Mod. OFF)	216kHz	TP002 (3-F) TP608 (5-D)	Proceedsame AutoAdjustmentof step (1) understep(4).

Extension Cable

* When repairing or measuring the voltage of this unit, connect with the Extension Cable as shown in below.

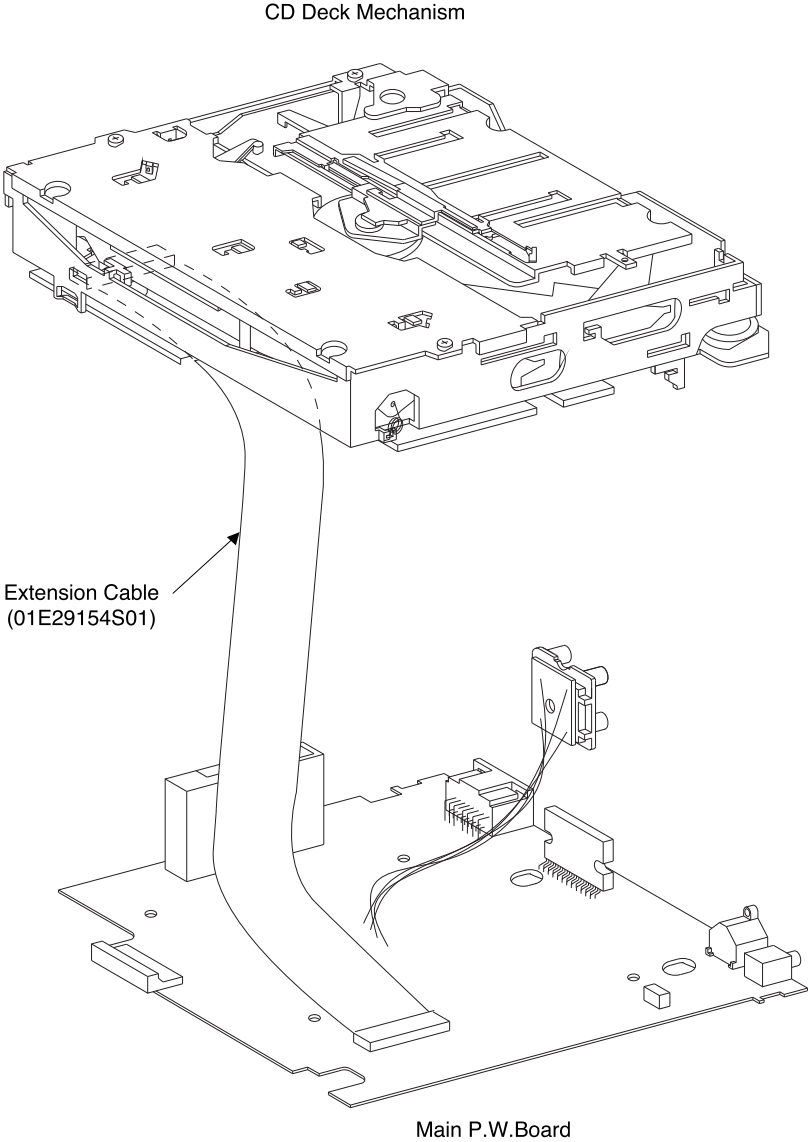

Block Diagram

CDM-9825RB

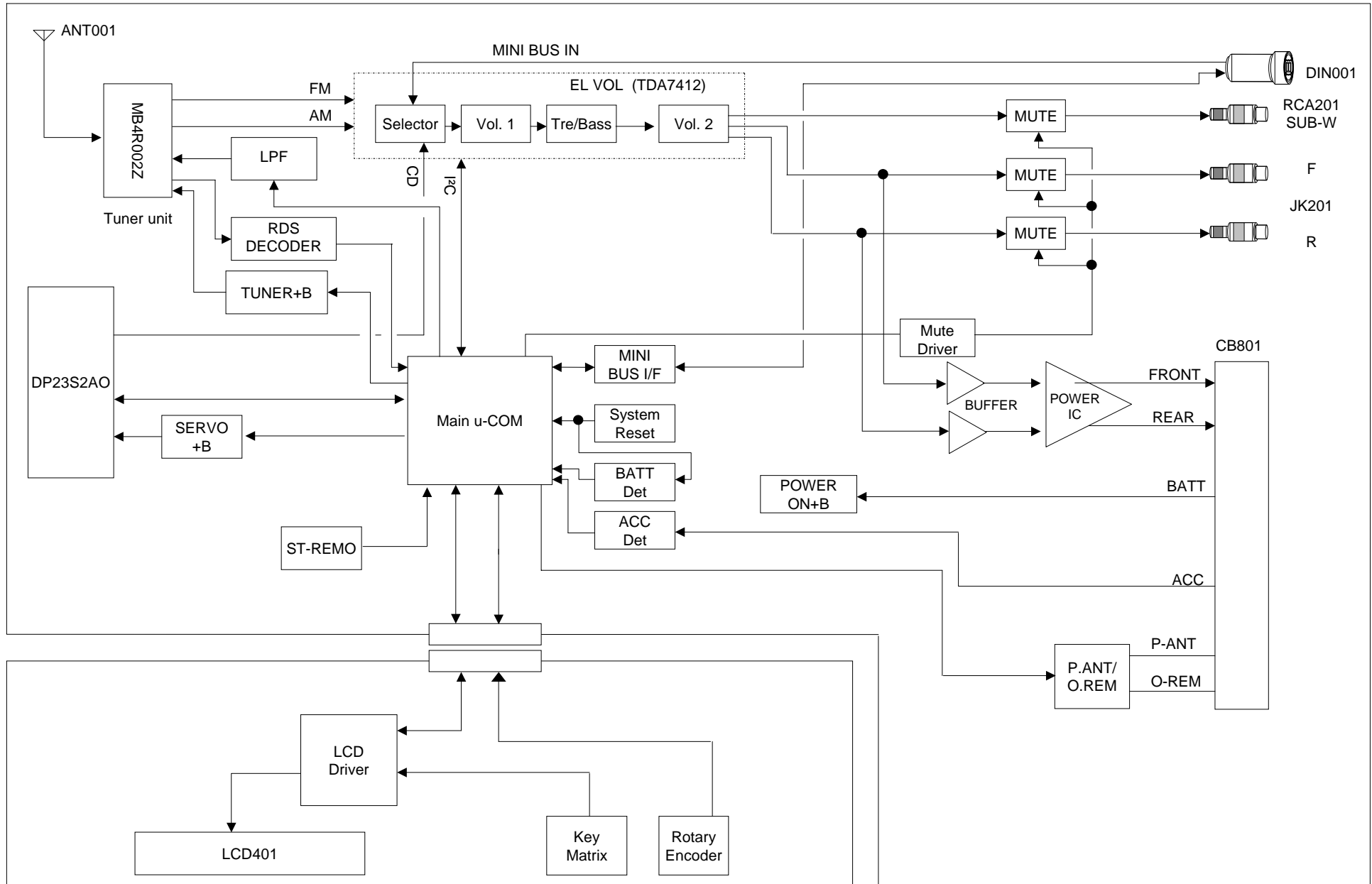

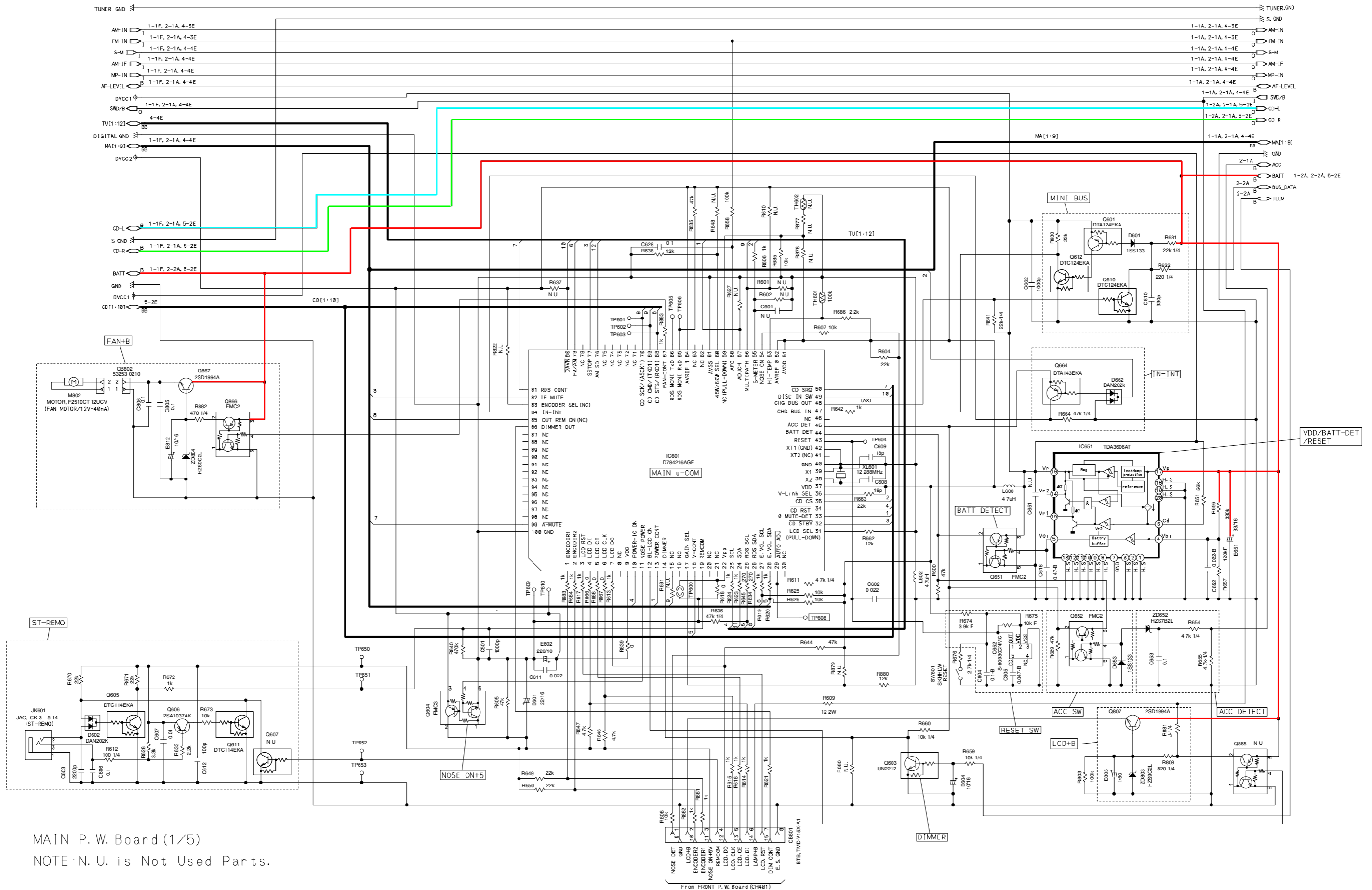

MAIN P. W. Board (1/5)
 NOTE : N. U. is Not Used Parts.

Schematic Diagram (2/7)

CDM-9825RB

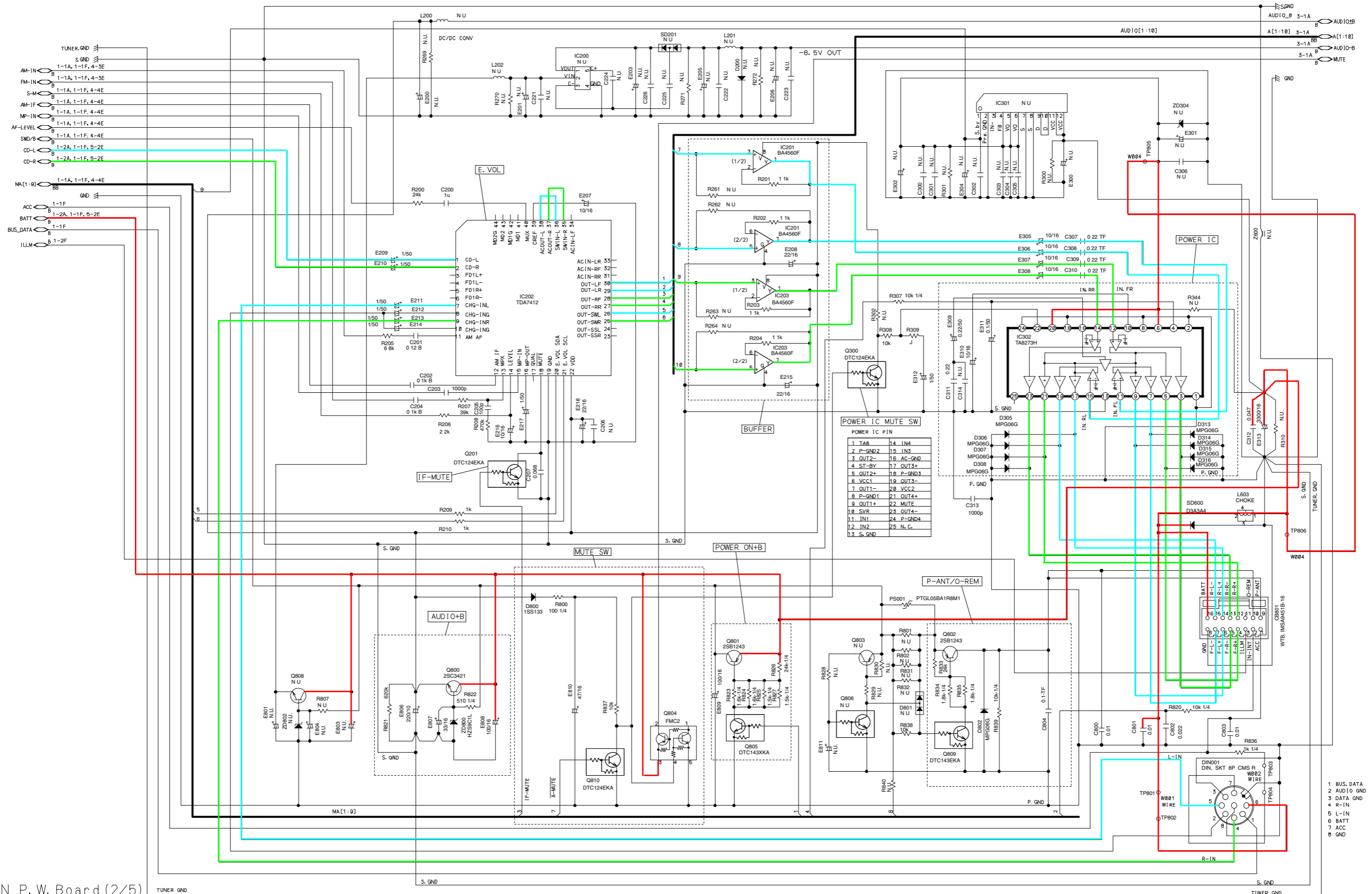

MAIN P.W. Board (2/5)
NOTE: N. U. is Not Used Parts.

- 1 BUS, DATA
- 2 AUDIO GND
- 3 DATA GND
- 4 R-IN
- 5 L-IN
- 6 BATT
- 7 ACC
- 8 GND

Schematic Diagram (3/7)

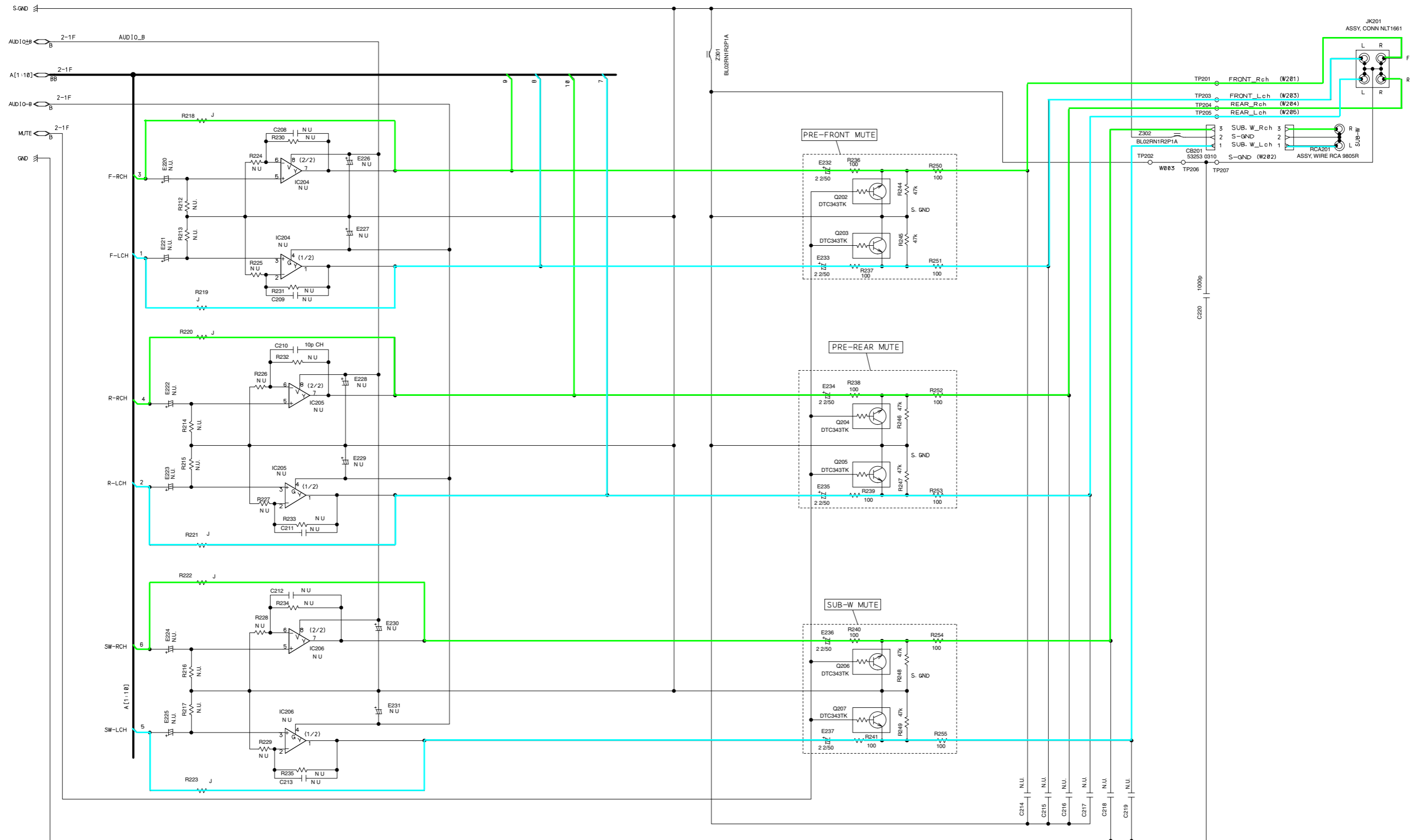

MAIN P. W. Board (3/5)
 NOTE: N. U. is Not Used Parts.

Schematic Diagram (4/7)

CDM-9825RB

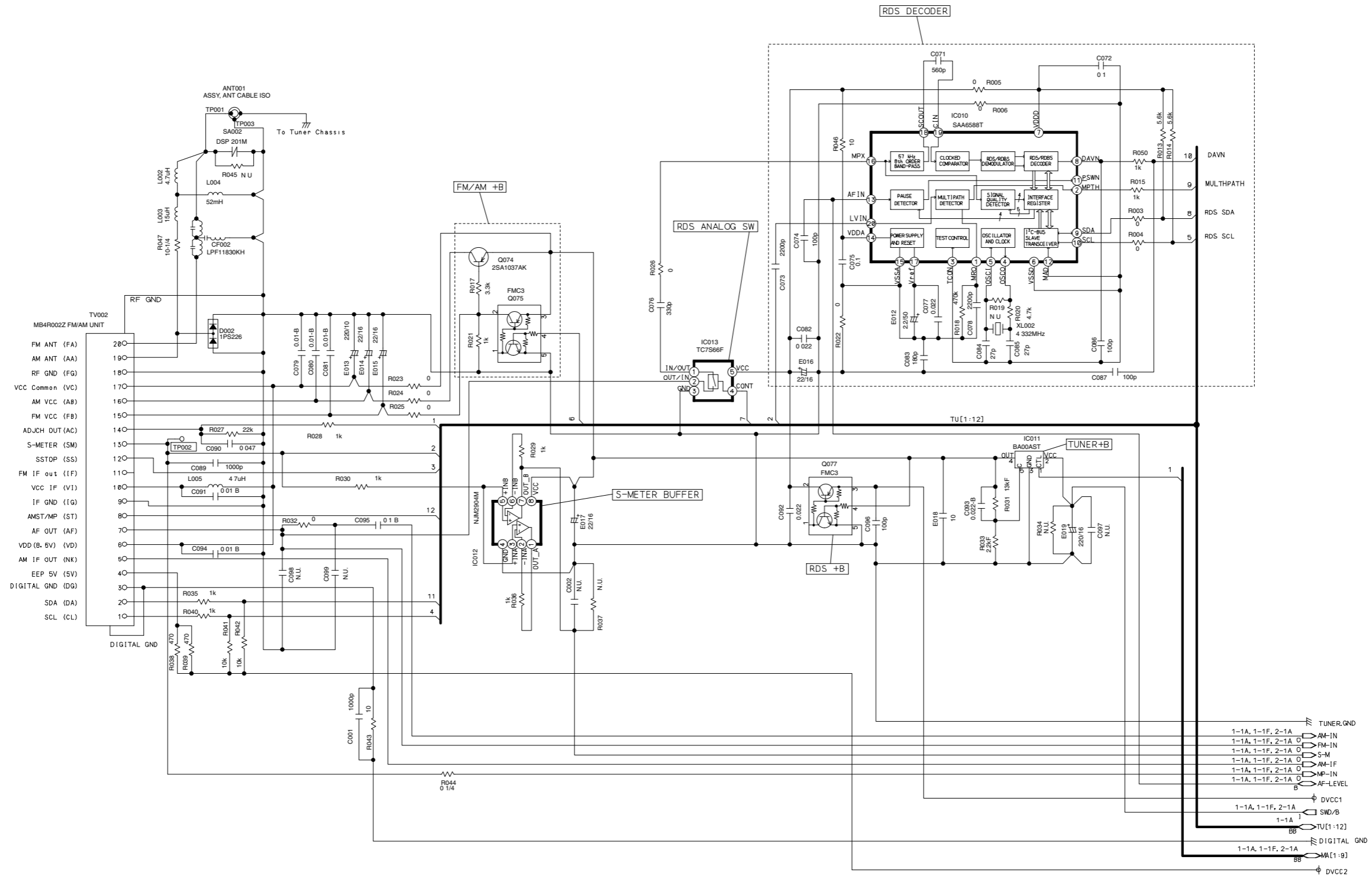

MAIN P.W. Board (4/5)
NOTE: N. U. is Not Used Parts.

Schematic Diagram (5/7)

CDM-9825RB

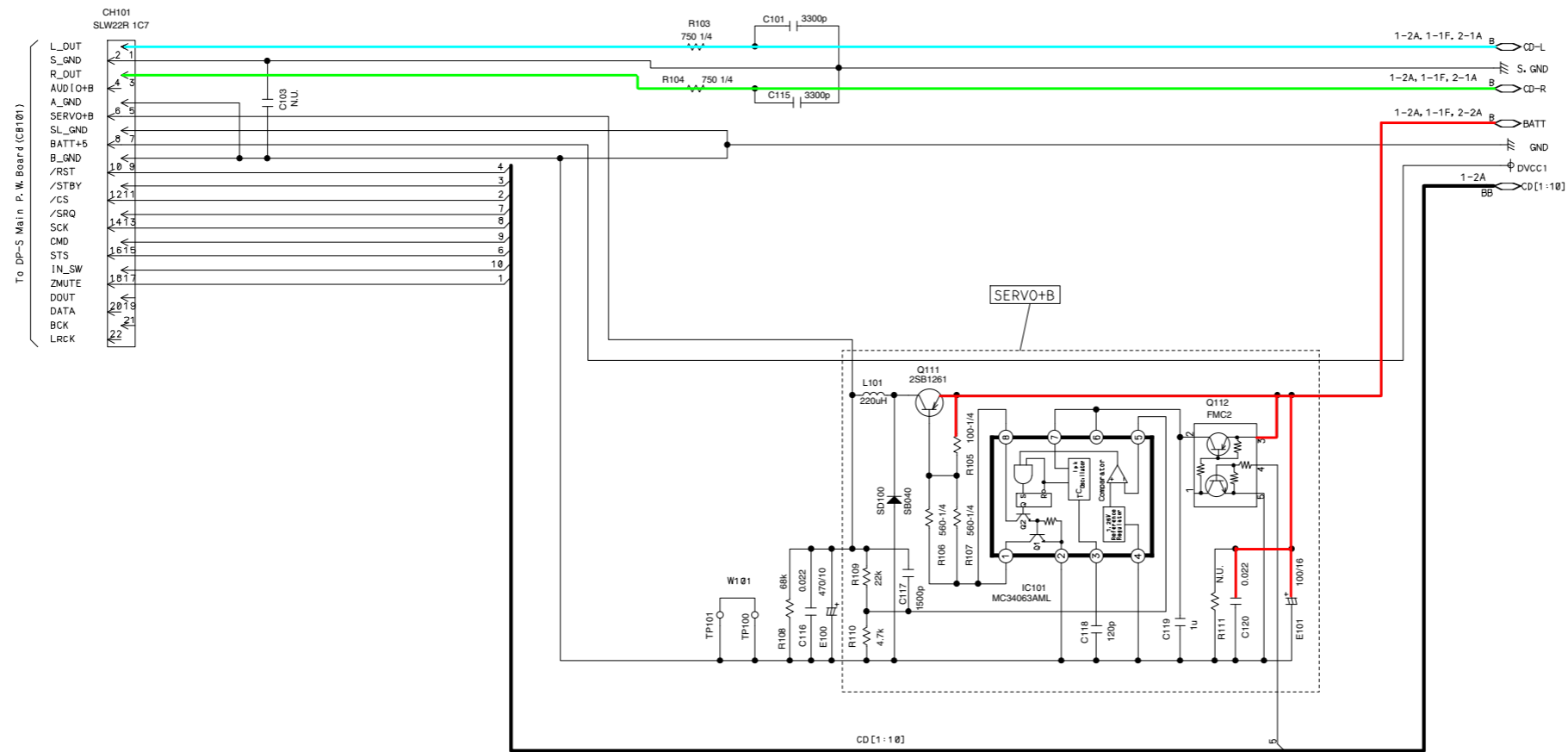

MAIN P.W. Board (5/5)
NOTE: N. U. is Not Used Parts.

Schematic Diagram (6/7)

CDM-9825RB

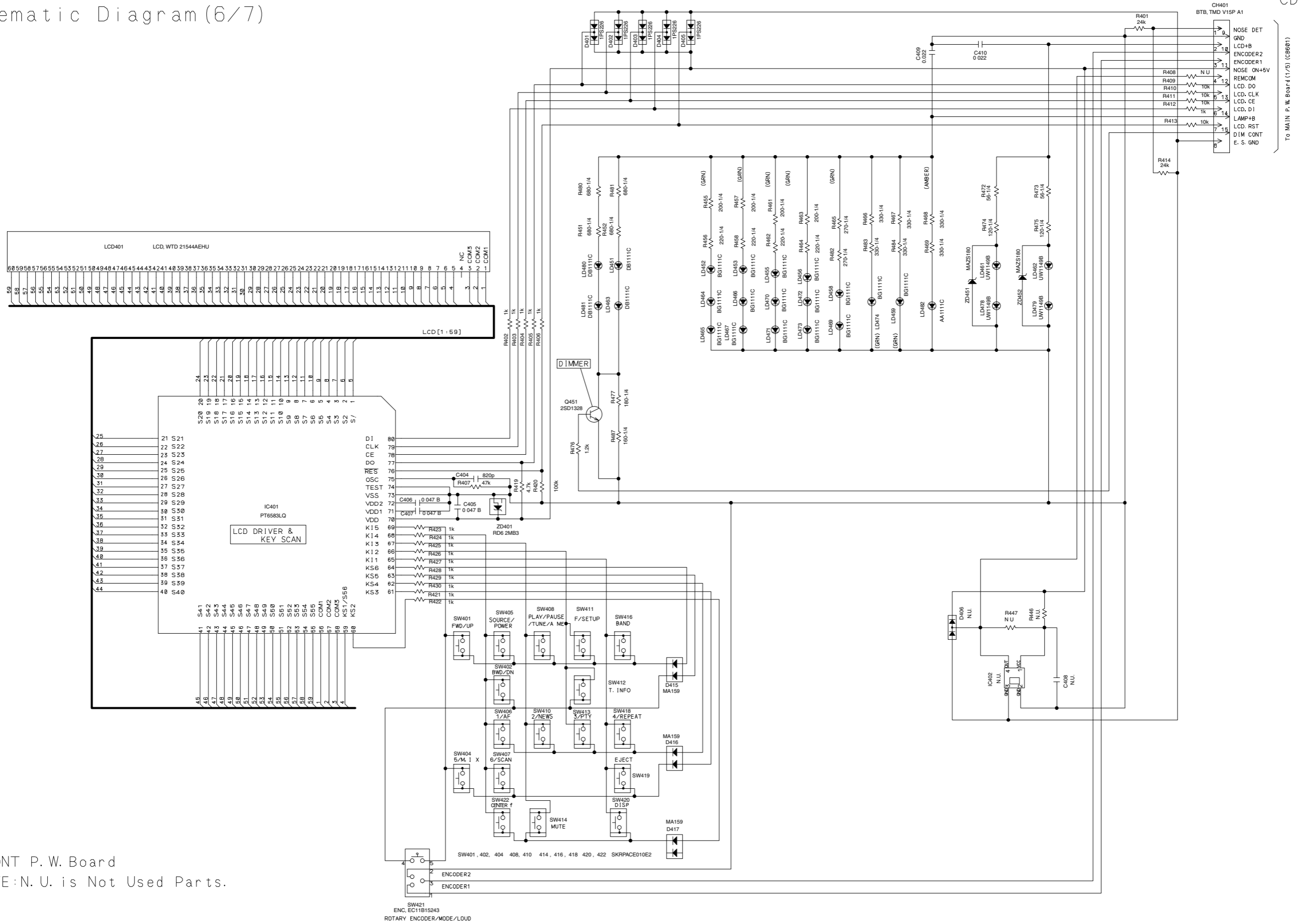

FRONT P.W. Board
NOTE: N. U. is Not Used Parts.

Schematic Diagram (7/7)

CDM-9825RB

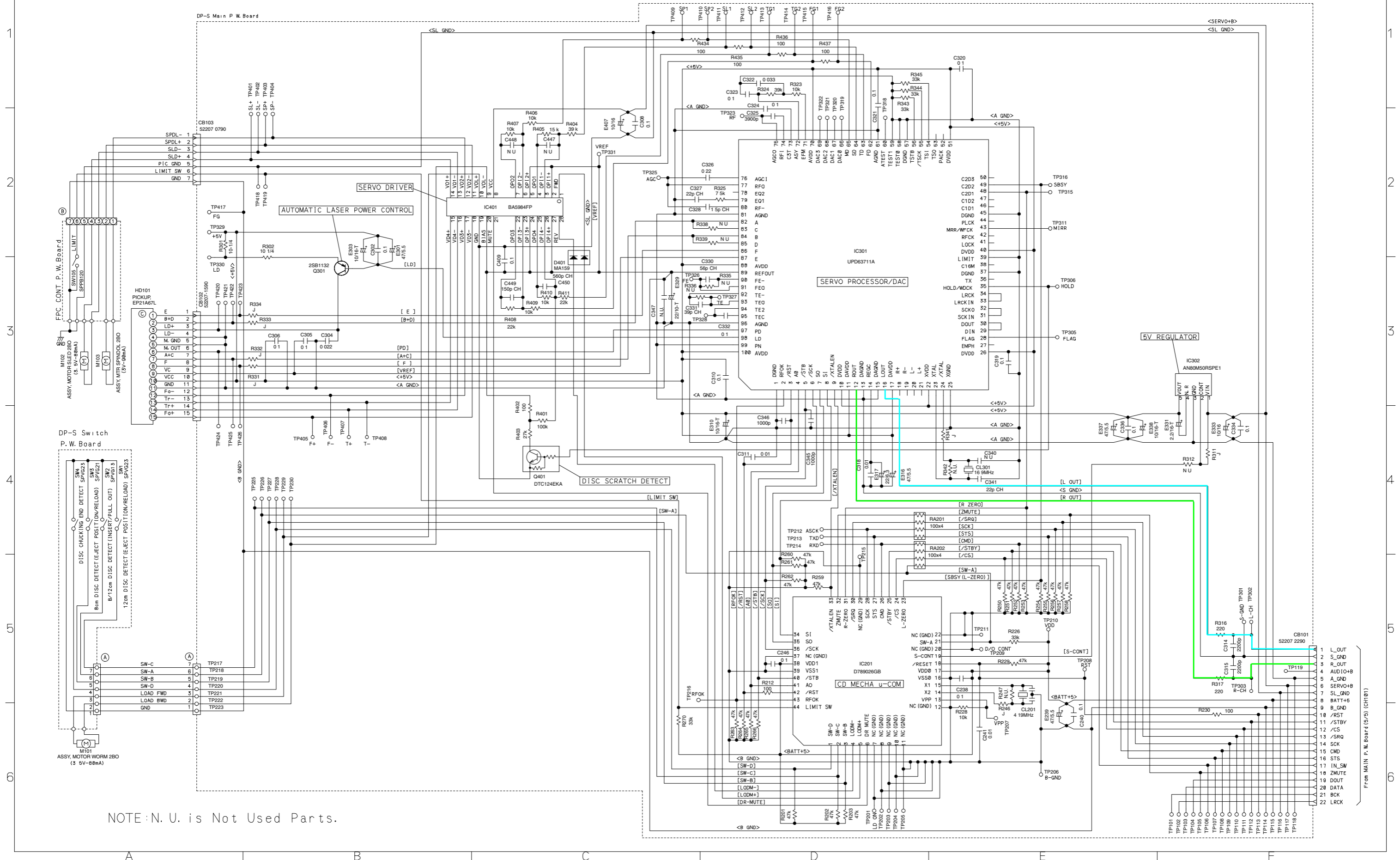

NOTE: N. U. is Not Used Parts.

Terminal Voltage of IC/TR

IC010			
1	PS	11	4.84
2	PS	12	PS
3	PS	13	2.39
4	2.44	14	4.76
5	2.05	15	0
6	PS	16	2.38
7	4.84	17	2.38
8	4.84	18	2.38
9	4.84	19	2.38
10	4.31	20	2.38

IC011	
1	4.83
2	14.21
3	0
4	8.44
5	1.22
6	0.48
7	0.48
8	8.4

IC012	
1	0.48
2	0.48
3	0.48
4	0
5	0.48

IC013	
1	3.04
2	3.04
3	0
4	4.92
5	4.84
6	14.3
7	14.3
8	10.4

IC101	
1	0
2	0.6
3	0
4	10.4
5	1.27
6	4.37
7	4.37
8	8.76

IC201	
1	4.37
2	4.37
3	4.37
4	0
5	4.37

IC202	
1	4.36
2	4.36
3	4.36
4	0
5	4.36
6	4.36
7	4.36
8	8.76

IC203					
1	4.34	CD	23	NC	
2	4.34	CD	24	NC	
3	NC		25	4.38	
4	NC		26	4.38	
5	NC		27	4.38	
6	NC		28	4.38	
7	4.33		29	4.38	
8	4.33		30	4.38	
9	4.33		31	NC	
10	4.33		32	NC	
11	4.33		33	NC	
12	4.35	AM	34	NC	
13	4.33		35	4.38	
14	4.39		36	4.38	
15	0		37	4.38	
16	4.8		38	4.38	
17	NC		39	4.38	
18	3.65		40	4.38	
19	0		41	NC	
20	0.5		42	NC	
21	0.5		43	NC	
22	8.77		44	NC	

IC302									
1	0	6	13.7	11	3.4	16	3.5	21	6.6
2	0	7	6.7	12	3.3	17	6.7	22	8.5
3	6.7	8	0	13	0	18	0	23	6.7
4	4.9	9	6.7	14	3.4	19	6.7	24	0
5	6.6	10	8.2	15	3.3	20	13.8	25	NC

IC401									
1	2.4	17	2.3	33	2.4	49	2.4	65	0
2	2.4	18	2.3	34	2.3	50	2.4	66	0
3	2.4	19	2.3	35	2.3	51	2.4	67	0
4	2.4	20	2.3	36	2.3	52	2.3	68	0
5	2.4	21	2.3	37	2.4	53	2.3	69	0
6	2.4	22	2.3	38	2.4	54	2.3	70	4.8
7	2.4	23	2.4	39	2.4	55	2.3	71	3.1
8	2.4	24	2.3	40	2.4	56	2.3	72	1.5
9	2.4	25	2.4	41	2.4	57	2.3	73	0
10	2.4	26	2.3	42	2.4	58	2.3	74	0
11	2.3	27	2.3	43	2.4	59	2.4	75	3.8
12	2.3	28	2.3	44	2.4	60	4.8	76	4.5
13	2.3	29	2.4	45	2.4	61	4.8	77	4.8
14	2.4	30	2.4	46	2.4	62	4.8	78	0.7
15	2.3	31	2.4	47	2.4	63	4.8	79	0.2
16	2.3	32	2.4	48	2.4	64	4.8	80	1.3

IC601-1									
1	4.86			21	NC			41	NC
2	4.86			22	0			42	0
3	1.93			23	4.92			43	4.91
4	1.31			24	4.92			44	4.94
5	0.7			25	4.33			45	4.93
6	0.27			26	4.82			46	NC
7	4.88			27	0			47	4.94
8	NC			28	0			48	0
9	4.93			29	4.92			49	4.94
10	4.93			30	NC			50	4.94
11	4.89			31	0			51	4.93
12	4.93			32	4.92			52	4.93
13	4.83			33	0			53	4.79
14	0/4.92	Dimmer ON/OFF		34	4.93			54	2.41
15	NC			35	4.91	CD		55	4.37
16	NC			36	4.92	CD		56	0
17	0			37	4.93			57	0
18	0			38	2.6			58	3
19	4.63			39	2.34			59	NC
20	NC			40	0			60	0

IC601-2							
61	0		74	PS		88	NC
62	NC		75	NC		89	NC
63	NC		76	4.57	AM	90	NC
64	4.93		77	3.81		91	NC
65	4.9		78	NC		92	NC
66	4.92		79	4.88		93	NC
67	0/4.9	FAN	80	4.84		94	NC
		OFF/ON	81	4.92		95	NC
68	3.23	CD	82	0		96	NC
69	4.91	CD	83	0		97	NC
70	4.78	CD	84	0		98	NC
71	NC		85	4.92		99	4.9
72	NC		86	NC		100	0
73	PS		87	NC			

IC651			
1	0	11	0
2	0	12	0
3	0	13	0
4	3.8	14	NC
5	4.86	15	NC
6	2.7	16	4.95
7	0	17	14.35
8	0	18	0
9	0	19	0
10	0	20	0

IC652	
1	4.91
2	4.92
3	0
4	NC
5	0

Pin No.	1	2	3	4	5	NOTE
Q075	NC	8.41	8.43	4.88	0	FM
		1.74	8.44	0	0	AM
Q077	NC	4.84	4.95	8.41	0	
Q112	NC	14.22	14.24	4.91	0	
Q604	NC	4.87	4.93	4.87	0	
Q651	NC	4.94	4.95	4.86	0	
Q652	NC	4.93	4.94	6.1	0	
Q804	NC	0	14	0	0	A-MUTE OFF
		14	14	4.5	0	A-MUTE ON
Q866	0	14.16	14.25	4.71	0	FAN ON

Pin No.	E	B	C	NOTE
Q074	8.41	8.29	0.31	FM
	8.41	7.67	8.35	AM
Q111	14.32	13.92	7.54	CD
Q201	0	0	3.64	
Q202	0	0	0	
Q203	0	0	0	
Q204	0	0	0	
Q205	0	0	0	
Q206	0	0	0	
Q207	0	0	0	
Q300	0	0	3.98	
Q451	0	0.8	0	Dimmer ON
Q601	4.95	4.93	0	
Q603	0	10	0	Dimmer ON
Q605	0	0	4.64	
Q606	4.87	4.86	0	
Q610	0	0	8.3	
Q611	0	0	0	
Q612	0	0	4.94	
Q664	4.9	4.9	0	
Q800	9.36	14.25	8.75	
Q801	13.53	14.2	14.27	
Q802	13.52	14.19	14.17	
Q805	0	4.82	0	
Q807	9.51	14.23	8.88	
Q809	0	4.85	0	
Q810	0	4.9	0	A-MUTE OFF
	0	0	4.9	A-MUTE ON
Q867	9.54	14.25	8.91	

[Measuring Conditions]

- 1.Power Supply Voltage : DC14.4V
- 2.Measuring Meter : Digital Multi Meter
- 3.Measuring Point Reference : Between GND
- 4.Measuring Condition : FM 98.1MHz
MW : 999KHz
LW : 216KHz
CD : at playing Disc

(CD Deck Mechanism)

IC201									
1	0	12	0	23	0 or 5		34	0-5	repeat of H to L
2	0	13	0	24	0-5	repeat of H to L	35	0-5	repeat of H to L
3	0	14	-	25	5		36	0-5	repeat of H to L
4	0	15	-	26	0-5	repeat of H to L	37	0	
5	0	16	0	27	0-5	repeat of H to L	38	5	
6	5	17	5	28	0-5	repeat of H to L	39	0	
7	0	18	5	29	0		40	0-5	repeat of H to L
8	0	19	5	30	0-5	repeat of H to L	41	0-5	repeat of H to L
9	0	20	0	31	0 or 5		42	5	
10	0	21	5	32	0 or 5		43	5	
11	0	22	0	33	0		44	5	

NOTE : - : indefinite voltage

IC301-1									
1	0		29	0-5			57	0	
2	5		30	0-5			58	0	
3	5		31	0-5	repeat		59	0	
4	0-5		32	0-5	of		60	NC	
5	0-5	repeat	33	0-5	H to L		61	0	
6	0-5	of	34	0-5			62	2.5±2.5	
7	0-5	H to L	35	0-5			63	2.5±2.5	
8	0-5		36	NC			64	2.5±2.5	
9	0		37	0			65	2.5±2.5	
10	5		38	NC			66	NC	
11	5		39	0			67	NC	
12	-		40	5			68	NC	
13	0		41	NC			69	NC	
14	2.5		42	NC			70	5	
15	0		43	NC			71	0.5-4.5	repeat
16	-		44	NC					of
17	5		45	0					H to L
18	NC		46	NC			72	2.5	
19	NC		47	NC			73	3	
20	NC		48	0			74	RF signal	
21	NC		49	0			75	RF signal	
22	5		50	NC			76	RF signal	
23	-		51	5			77	RF signal	
24	-		52	NC			78	NC	
25	0		53	NC			79	RF signal	
26	5		54	0			80	2.5	
27	NC		55	0			81	0	
28	NC		56	0			82	about 2.8	

NOTE : - : indefinite voltage

IC301-2					
83	NC	89	2.5	95	about 2.5
84	about 2.8	90	about 2.5	96	0
85	NC	91	about 2.5	97	0.17
86	about 2.9	92	about 2.5	98	-
87	about 2.9	93	about 2.5	99	0
88	5	94	about 2.5	100	5

IC302	
1	7
2	7 or 5
3	0
4	1.4
5	5

IC401							
1	0	8	7	15	-	22	about 2.5
2	2.5	9	0	16	-	23	about 2.5
3	about 2.5	10	0	17	-	24	2.5
4	about 2.5	11	-	18	-	25	about 2.5
5	2.5	12	-	19	0	26	about 2.5
6	about 2.5	13	-	20	2.5	27	2.5
7	about 2.5	14	-	21	5	28	0

NOTE : - : indefinite voltage

Q301	
B	3.9
C	2.4
E	4.5

Q401		
E	0	
B	0-5	repeat of H tp L
C	0-2.5	repeat of H to L

[Measuring Conditions]

1. Power Supply Voltage : DC14.4V
2. Measuring Meter : Digital Multi Voltmeter
3. Measuring Point Reference : Between GND
4. Measuring Condition : at playing disc

Description of IC Terminal

D784216AGF : IC601

No.	Symbol	I/O	Terminal Description
1	ENCODER1	I	Encoder Data input terminal.
2	ENCODER2		
3	LCD RST	O	RESET signal output terminal to LCD Driver (PT6583LQ).
4	LCD DI	O	Serial Data signal output terminal to LCD Driver (PT6583LQ).
5	LCD CE	O	Chip Enable signal output terminal to LCD Driver (PT6583LQ).
6	LCD CLK	O	Serial Clock signal output terminal to LCD Driver (PT6583LQ).
7	LCD DO	I	Serial Data signal input terminal from LCD Driver (PT6583LQ).
8	NC	-	No connect terminal.
9	VDD	-	Power supply terminal.
10	POWER-IC ON	O	STBY CONT signal output terminal to Power IC.
11	NOSE POWER	O	Power supply control signal output terminal of LCD Driver and Remote Control.
12	BL-LCD ON	O	Power supply control signal output terminal of LCD backlighting.
13	POWER CONT	O	Power supply control signal output terminal of Audio and Key lighting.
14	DIMMER	I	Dimmer control signal input terminal
15	NC	-	No connect terminal.
16			
17	GAIN SEL	I	Sub-W output GAIN set up input terminal.
18	V-CONT	O	Power supply control signal output terminal of Servo/Mechanism.
19	REMOCON	I	Remote Control Data input terminal.
20	NC	-	No connect terminal.
21			
22	Vpp	-	Flash Memory writing terminal.
23	SCL	O	Serial Clock signal output terminal to TUNER.
24	SDA	I/O	Serial Data signal input/output terminal to TUNER.
25	RDS SCL	O	RDS Clock output terminal from RDS Decoder (SAA6588T).
26	RDS SDA	I/O	RDS Data input/output terminal to RDS Decoder (SAA6588T).
27	E.VOL SCL	O	Serial Clock signal output terminal to E.VOL (TDA7412).
28	E.VOL SDA	I/O	Serial Data signal input/output terminal to E.VOL (TDA7412).
29	AUTO ADJ	I	Auto adjustment control signal input terminal. (L : Auto adjustment)
30	NC	-	No connect terminal.
31	LCD SEL(PULL-DOWN)	-	Pull-down connect terminal.
32	CD STBY	O	Stand-by control signal output terminal of Mechanism u-COM.
33	0 MUTE-DET	I	0-bit MUTE signal input terminal.
34	CD RST	O	RESET signal output terminal of Mechanism u-COM.
35	CD CS	O	Communication control signal output terminal of Mechanism u-COM.
36	V-Link SEL	I	V-Link set up input terminal.
37	VDD	-	Power supply terminal.
38	X2	-	Main System Clock OSC input terminal. (12.288MHz)
39	X1		
40	GND	-	GND connect terminal.
41	XT2(NC)	-	No connect terminal.
42	XT1(GND)	-	GND connect terminal.
43	RESET	I	System RESET signal input terminal.
44	BATT DET	I	BATT detect signal input terminal. (Compulsion Stand-by)
45	ACC DET	I	ACC (IGNITION) detect signal input terminal.
46	NC	-	No connect terminal.

No.	Symbol	I/O	Terminal Description
47	CHG BUS IN	I	Signal input terminal from CD CHANGER BUS I/F.
48	CHG BUS OUT	O	Signal output terminal to CD CHANGER BUS I/F.
49	DISC IN SW	I	DISC insert detect SW input terminal.
50	$\overline{CD SRQ}$	I	Communication request signal input terminal from Mechanism u-COM.
51	AVDD	-	Analog power supply terminal of A/D Converter.
52	AVREF 0	-	Standard voltage input terminal of A/D Converter.
53	HI-TEMP	I	Temperature sensor signal (Thermistor) input terminal for CD.
54	NOSE ON	I	FRONT Panel detect signal input terminal.
55	S-METER	I	Signal Meter input terminal.
56	MULTIPATH	I	Multipath rejection detect terminal of receiving station.
57	ADJCH	I	Adjoining channel signal input terminal.
58	AFC	I	AFC signal input terminal.
59	NC(PULL-DOWN)	-	Pull-down connect terminal.
60	45W/60W SEL	I	45W/60W set up input terminal.
61	AVSS	-	GND terminal of A/D Converter.
62	NC	-	No connect terminal.
63			
64	AVREF 1	-	Standard voltage input terminal of A/D Converter.
65	RDS MONI RxD	I	Serial Data input terminal from RDS Monitor Soft (P/C).
66	RDS MONI TxD	O	Serial Data output terminal to RDS Monitor Soft (P/C).
67	FAN-CONT	O	FAN control signal output terminal. (H : FAN ON, L : FAN OFF)
68	CD STS	I	Status signal input terminal from Mechanism u-COM.
	(RXD1)	-	(Flash-Pro II connect terminal by UART format.)
69	CD CMD	O	Command output terminal to Mechanism u-COM.
	(TXD1)	-	(Flash-Pro II connect terminal by UART format.)
70	CD SCK	O	Serial Clock output terminal to Mechanism u-COM.
	(ASCK1)	-	(Flash-Pro II connect terminal by UART format.)
71	NC	-	No connect terminal.
I			
75			
76	AM SD	I	AM SD signal input terminal.
77	SSTOP	I	Seek Stop signal input terminal of TUNER.
78	NC	-	No connect terminal.
79	FM/AM	O	FM/AM power switching signal output terminal. (H : FM, L : AM)
80	\overline{DAVN}	I	Available input terminal of RDS Decoder (SAA6588T).
81	RDS CONT	O	MPX MUTE signal output terminal to RDS Decoder (SAA6588T) at FM adjoining rejection.
82	IF MUTE	O	High Speed MUTE signal output terminal at AF SW.
83	ENCODER SEL(NC)	-	No connect terminal.
84	IN-INT	I	Outernal AUDIO signal input terminal.
85	OUT REM ON(NC)	-	No connect terminal.
86	NC		
I			
98			
99	A-MUTE	O	AUDIO MUTE signal output terminal. (L : MUTE ON)
100	GND	-	GND connect terminal.

D789026GB : IC201 (DP23S2A0)

No.	Symbol	I/O	Terminal Description
1	SW-D	I	SW-D input terminal for mechanism control.
2	SW-C	I	SW-C input terminal for mechanism control.
3	SW-B	I	SW-B input terminal for mechanism control.
4	LODM-	O	Loading Motor control output terminal.
5	LODM+		
6	DR MUTE	O	Driver IC Mute control output terminal.
7	NC(GND)	-	GND connect terminal.
11			
12			
13	VPP	-	Pull-down connect terminal.
14	X2	-	Crystal OSC connect terminal. (4.19MHz)
15	X1		
16	VSS0	-	GND connect terminal.
17	VDD0	-	VDD connect terminal.
18	/RESET	I	Host I/F RESET signal input terminal.
19	S-CONT	O	Servo power supply control output terminal.
20	NC(GND)	-	GND connect terminal.
21	SW-A	I	SW-A input terminal for mechanism control.
22	NC(GND)	-	GND connect terminal.
23	L-ZERO	I	DSP L-ch 0 data signal input terminal.
24	/CS	I	Host I/F communication start/end signal input terminal.
25	/STBY	I	Host I/F STBY signal input terminal.
26	CMD	I	Host I/F command input terminal.
27	STS	O	Host I/F status output terminal.
28	SCK	I	Clock input terminal for Host I/F communication.
29	NC(GND)	-	GND connect terminal.
30	/SRQ	O	Host I/F status request signal output terminal.
31	R-ZERO	I	DSP R-ch 0 data signal input terminal.
32	ZMUTE	O	Host I/F 0 data signal output terminal.
33	/XTALEN	O	DSP crystal OSC control output terminal.
34	SI	O	DSP serial data output terminal.
35	SO	I	DSP serial data/status signal input terminal.
36	/SCK	O	Clock output terminal for DSP serial data.
37	NC(GND)	-	GND connect terminal.
38	VDD1	-	VDD connect terminal.
39	VSS1	-	GND connect terminal.
40	/STB	O	DSP data strobe signal output terminal.
41	AO	O	DSP command/parameter discrimination signal output terminal.
42	/RST	O	DSP RESET signal output terminal.
43	RFOK	I	DSP RFOK signal input terminal.
44	LIMIT SW	I	LIMIT-SW input terminal.

Exploded View (Cabinet)

CDM-9825RB

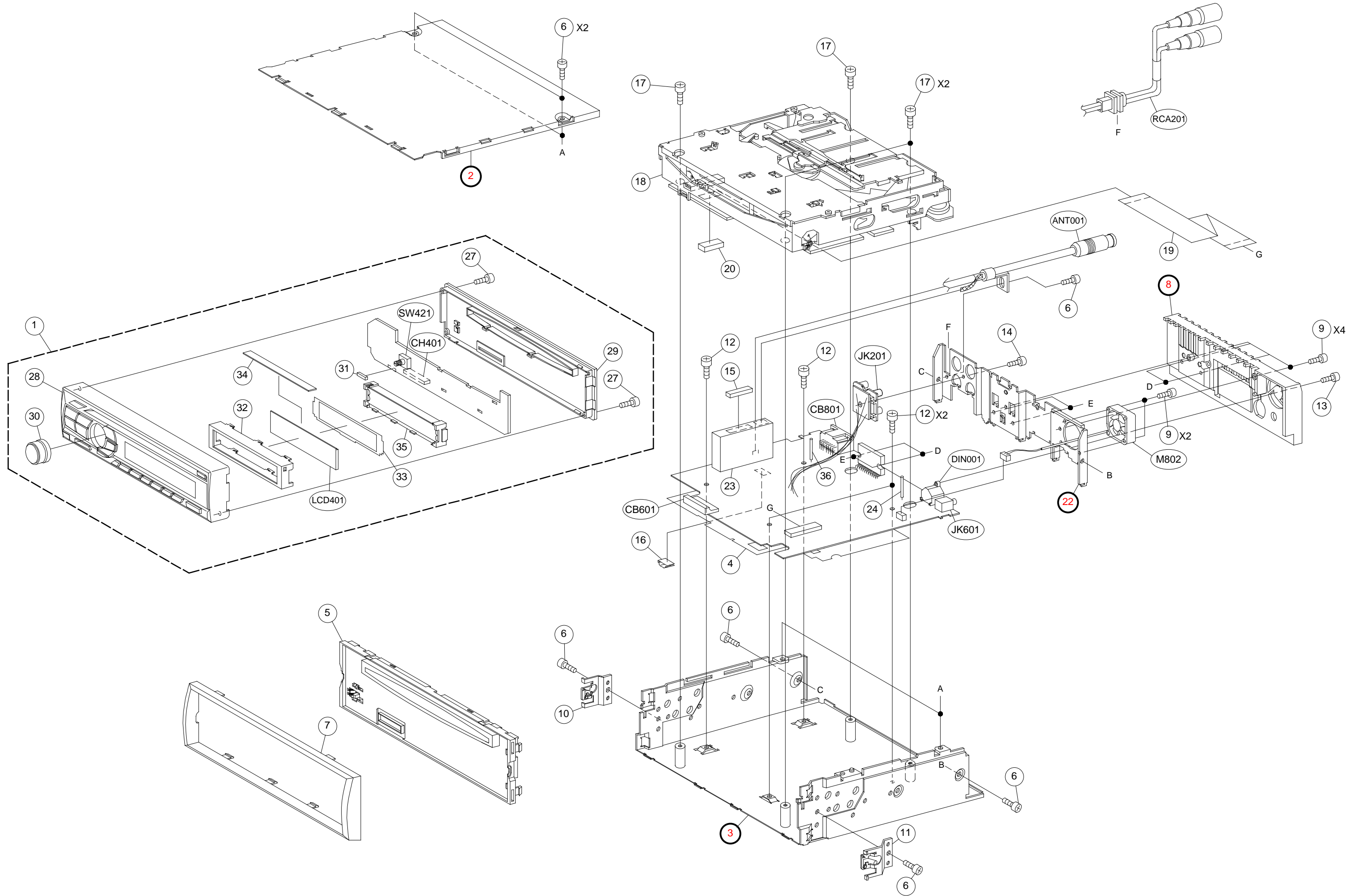

Exploded View (CD Deck Mechanism)

CDM-9825RB

(DP23S2AO)

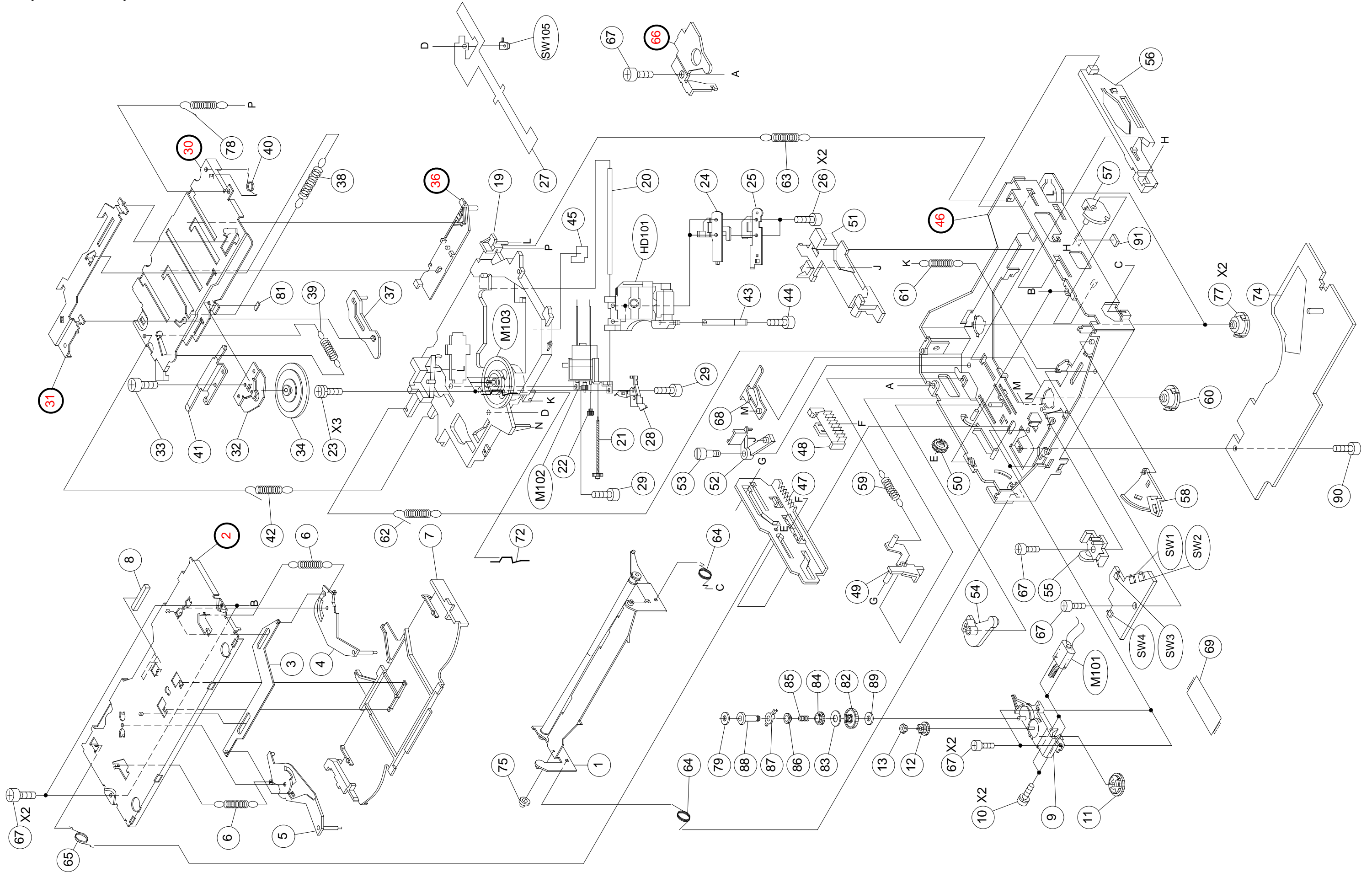

CDM-9825RB

Cabinet Assembly Parts List

Note : The part that has not PART NUMBER will not be supplied.

1	01V74500Y96	ASSY,NOSE UNIT 25RN
2	-----	COVER, TOP
3	-----	CHAS, BASE
4	14B02859K01	INSULATOR, MAIN
5	13C02811K01	NOSE, BASE ASSY
6	03S60822Y12	SCR, S-T 2.6X6 ZN A
7	33C01797K05	FACE, PLATE
8	-----	HEAT, SINK(SW)
9	03S60822Y22	SCR, S-T 2.6X14 ZN A
10	07D00749K01	BKT, SIDE L
11	07D00749K02	BKT, SIDE R
12	03T25225Y01	SCR, GND
13	03S60824Y09	SCR, WEV 2.6X10 ZN A
14	03S60825Y04	SCR, B-T 3X8 ZN A
15	75T25010Y33	CUSHION, SHLD5-5.5-25
16	41A03685K01	SPRING, SHIELD
17	03S60822Y10	SCR, S-T 2.6X5 ZN A
18	81D50617Y01	DP23S2A0, CD MECH
19	30T03013K03	SMCD22X120BDX6(BL)M
20	75S40755Y78	CUS, RUB 11X5XT4.5
22	-----	BKT, CHAS REAR(SW)
23	77T04258K01	MB4R002Z(SHA)T.UNIT(TU002)
24	09T84840F01	LUG, STYLE 18MM
27	03S71677F56	SCR, B-TITE M1.7X12
28	13D02846K08	NOSE, PIECE ASSY(L)
29	13D02810K02	NOSE, BOTTOM
30	36B02841K02	KNOB, ROTARY ASSY
31	75S40755Y94	CUS, RUB 10X2XT3
32	15B01768K01	COVER, LCD
33	26A01773K01	REFLECTOR, SHEET
34	75T03213K02	RUBBER, ELECTRIC
35	15D01770K01	CASE, LCD ASSY
36	09T84840F02	LUG, STYLE 32MM

CD Deck Mechanism Assembly Parts List

Note : The part that has not PART NUMBER will not be supplied.

1	01V43800Y84	ASSY,ARM GUIDE 280
2	-----	CHASSIS, TOP
3	45B11564Y02	LEVER, LINK-TOP
4	45B11595Y02	LEVER DISC(R)
5	45B11596Y02	LEVER, DISC(L)
6	41B11613Y16	SPRING, PULL
7	15D50248Y02	GUIDE, TOP-DPS2
8	75A21286Y04	CUSHION, CLAMPER DPS2
9	07C50608Y01	BKT, MOTOR LOAD-P
10	03S40014G07	SCR, MCH M2X4
11	44B11578Y02	GEAR, (A)
12	44B11579Y02	GEAR, (B)
13	44B11580Y02	GEAR, (C)
19	27D11602Y04	CHASSIS, PICKUP
20	47A11575Y01	SHAFT, PICK
21	01V28100Y59	ASSY, SHAFT. SCREW
22	44A70590W03	GEAR, MIDDLE
23	03S72235F96	SCR, MCH M1.7X3.5(SW)
24	07B30337Y02	BKT, SPRING NUT
25	41A11606Y02	SPRING NUT
26	03S94385F18	SCR, NYLON M2X3.5
27	84T01803K01	PANEL, FPC CONT
28	41B11566Y02	SPRING, SHAFT
29	03S70494F13	SCR, P-TITE M2X6 BLK
30	-----	ASSY, RIV. ARM CLAMP
31	-----	LEVER, LOCK
32	07A11565Y02	PLATE, CLAMP
33	03S94385F01	SCR, NYLOK M1.7X2.3
34	43A41812Y02	TABLE, CLAMPER2
36	-----	SLIDER DISC
37	45A11599Y02	LEVER, ACTUATOR
38	41B11613Y03	SPRING, PULL
39	41B11613Y05	SPRING, LEV-ACT
40	41A11609Y01	SPRING, LEVER
41	41B40574Y02	SPRING, PLATE-S
42	41B11613Y15	SPRING, PULL
43	41A11040Y02	SPRING, SLED-HOE
44	03S70494F52	SCR, P-TITE M1.4X4.5
45	43A21240Y01	SHEET, FPC PICK
46	ASSY, RIV CH	AS BASE
47	45B40510Y02	SLIDER, LOAD
48	44B40527Y02	RACK

CDM-9825RB

49	45A11601Y02	LEVER,TRIGER
50	44B11581Y02	GEAR,(D)
51	45B11594Y02	SLIDER,LOCK(L)
52	45A11592Y02	ARM,LOCK(L2)
53	03A11574Y01	SCREW,LOCK
54	45B11591Y02	ARM,LOCK(L1)
55	07A50606Y01	BKT,MOTOR WIRE-P
56	45B11593Y02	SLIDER,LOCK(R)
57	45B11607Y02	ARM,LOCK(R)
58	45A11597Y02	LEVER,SW
59	41B11613Y04	SPRING,TRIGER
60	75C30466Y14	DAMPER,DPS2
61	41B11613Y06	SPRING,PULL
62	41B11613Y07	SPRING,PULL
63	41B11613Y08	SPRING,PULL
64	41A40518Y01	SPRING,ROL
65	41A31894Y02	SPRING,SLIDER
66	-----	BKT,SP-TOP
67	03A21791Y01	SCREW,M2X3.5 S-TITE
68	07B20905Y02	BKT,FPC CONT
69	30T15126W15	WIRE,PC JOINT 7P
72	41A21613Y02	SPRING,SPINDLE
74	14A30831Y01	INS,CVR
75	43A31443Y01	ROLLER,ARM DISC (C)
77	75C30466Y15	DAMPER,DPS2
78	41B11613Y14	SPLING,PULL
79	04B41345P52	WASH,1.6X3.5X0.25
81	75A21286Y02	CUSHION,CLAMPER BACK
82	44B40523Y02	GEAR,BASE
83	04A40528Y01	WASHER,FELT
84	44A40524Y02	GEAR,CLUTCH
85	41A40529Y01	SPRING,CLUTCH
86	44A40525Y02	GEAR,PINION
87	15A40526Y02	HOLDER,CLUTCH
88	43A41446Y02	SLEEVE,CLUTCH
89	04B41345P25	WASH,L. 3.1X6X0.35
90	03S44205G99	SCR,T-TITE M2X3
91	75A21286Y05	CUSHION,PWB

Electrical Parts List

* Each parts on P.W.Board are described in order of the reference number.

=====MAIN P.W.Board		
C001	08S45677W60	CAP,CER 102J-CH1H-CP
C071	08S45677W54	CAP,CER 561J-CH1H-CP
C072	08S45676W85	CAP,CER 104K-B1C -CP
C073	08S45676W65	CAP,CER.222K-B1H -CP
C074	08S45677W36	CAP,CER.101J-CH1H-CP
C075	08S45676W85	CAP,CER 104K-B1C -CP
C076	08S45677W48	CAP,CER.331J-CH1H-CP
C077	08S45676W80	CAP,CER 223K-B1E -CP
C078	08S45676W65	CAP,CER.222K-B1H -CP
C079	08S45676W73	CAP,CER.103K-B1H -CP
C080	08S45676W73	CAP,CER.103K-B1H -CP
C081	08S45676W73	CAP,CER.103K-B1H -CP
C082	08S45676W80	CAP,CER 223K-B1E -CP
C083	08S45677W42	CAP,CER.181J-CH1H-CP
C084	08S45677W22	CAP,CER.27RJ-CH1H-CP
C085	08S45677W22	CAP,CER.27RJ-CH1H-CP
C086	08S45677W36	CAP,CER.101J-CH1H-CP
C087	08S45677W36	CAP,CER.101J-CH1H-CP
C089	08S45677W60	CAP,CER 102J-CH1H-CP
C090	08S45676W89	CAP,CER 473K-B1E -CP
C091	08S45676W73	CAP,CER.103K-B1H -CP
C092	08S45676W80	CAP,CER 223K-B1E -CP
C093	08S45676W80	CAP,CER 223K-B1E -CP
C094	08S45676W73	CAP,CER.103K-B1H -CP
C095	08S45676W85	CAP,CER 104K-B1C -CP
C096	08S45677W36	CAP,CER.101J-CH1H-CP
C101	08S45676W67	CAP,CER.332K-B1H -CP
C115	08S45676W67	CAP,CER.332K-B1H -CP
C116	08S45676W80	CAP,CER 223K-B1E -CP
C117	08S45676W63	CAP,CER 152K-B1H -CP
C118	08S45677W38	CAP,CER 121J-CH1H-CP
C119	08S60102F48	CAP,CER 105K-B1E -CP
C120	08S45676W80	CAP,CER 223K-B1E -CP
C200	08S60102F48	CAP,CER 105K-B1E -CP
C201	08S45676W74	CAP,CER 123K-B1H -CP
C202	08S45676W85	CAP,CER 104K-B1C -CP
C203	08S45677W60	CAP,CER 102J-CH1H-CP
C204	08S45676W85	CAP,CER 104K-B1C -CP
C205	08S45677W36	CAP,CER.101J-CH1H-CP
C207	08S45676W84	CAP,CER 683K-B1C -CP
C220	08S45677W60	CAP,CER 102J-CH1H-CP
C307	08T35122W17	CAP,MMTS-224-J -R5
C308	08T35122W17	CAP,MMTS-224-J -R5
C309	08T35122W17	CAP,MMTS-224-J -R5
C310	08T35122W17	CAP,MMTS-224-J -R5

C311	08S45676W93	CAP,CER 224K-B1A -CP
C312	08S45676W89	CAP,CER 473K-B1E -CP
C313	08S45677W60	CAP,CER 102J-CH1H-CP
C501	08S45677W60	CAP,CER 102J-CH1H-CP
C602	08S65128F78	CAP,CER.223K-B1H -CP
C603	08S45676W65	CAP,CER.222K-B1H -CP
C604	08S35374W01	CAP,CER 104K-B1E-CP
C605	08S65128F90	CAP,CER 473K-B1H -CP
C606	08S65128F88	CAP,CER 104K-B1H -CP
C607	08S45676W73	CAP,CER.103K-B1H -CP
C608	08S45677W18	CAP,CER.18RJ-CH1H-CP
C609	08S45677W18	CAP,CER.18RJ-CH1H-CP
C610	08S45677W48	CAP,CER.331J-CH1H-CP
C611	08S45676W80	CAP,CER 223K-B1E -CP
C612	08S45677W36	CAP,CER.101J-CH1H-CP
C618	08S60102F44	CAP,CER 474K-B1E -CP
C628	08S45676W85	CAP,CER 104K-B1C -CP
C652	08S45676W80	CAP,CER 223K-B1E -CP
C653	08S45676W85	CAP,CER 104K-B1C -CP
C662	08S45677W60	CAP,CER 102J-CH1H-CP
C800	08S45539Y04	CAP,CER 103KX7R2J-CP
C801	08S45539Y04	CAP,CER 103KX7R2J-CP
C802	08S45676W80	CAP,CER 223K-B1E -CP
C803	08S45539Y04	CAP,CER 103KX7R2J-CP
C804	08T35122W13	CAP,MMTS-104-J -R5
C805	08S35374W01	CAP,CER 104K-B1E-CP
C806	08S35374W01	CAP,CER 104K-B1E-CP
CB201	09T25436Y03	WTB,53253-0310 -DB
CB802	09T25436Y02	WTB,53253-0210 -DB
CF002	91T75257W02	LPF,LPF11830KH-3C-DB
CH101	09T25684Y22	FFC,SLW22R-1C7 -DB
D002	48T85357W01	DIO,1PS226 -CP
D305	48T85270W01	DIO,MPG06G -A5
D306	48T85270W01	DIO,MPG06G -A5
D307	48T85270W01	DIO,MPG06G -A5
D308	48T85270W01	DIO,MPG06G -A5
D313	48T85270W01	DIO,MPG06G -A5
D314	48T85270W01	DIO,MPG06G -A5
D315	48T85270W01	DIO,MPG06G -A5
D316	48T85270W01	DIO,MPG06G -A5
D601	48T68828F01	DIO,1SS133 -A5
D602	48T63462F01	DIO,CP.DAN202K -96
D653	48T68828F01	DIO,1SS133 -A5
D662	48T63462F01	DIO,CP.DAN202K -96
D800	48T68828F01	DIO,1SS133 -A5
D802	48T85270W01	DIO,MPG06G -A5
E012	23S75373W14	CAP,ELY 2R2-1H -R2
E013	23S75372W03	CAP,ELY 221-1A -H2
E014	23S75373W03	CAP,ELY 22R-1C -R2
E015	23S75373W03	CAP,ELY 22R-1C -R2

CDM-9825RB

E016	23S75373W03	CAP,ELY 22R-1C -R2
E017	23S75373W03	CAP,ELY 22R-1C -R2
E018	08T65231Y03	CAP,CER 106K-BJ1E-CP
E019	23S95415W07	CAP,ELY 221-1C -R2
E100	23T55378W03	CAP,KMG 471-1A -R2
E101	23S75373W06	CAP,ELY 101-1C -R2
E207	23S75373W02	CAP,ELY 10R-1C -R2
E208	23S75373W03	CAP,ELY 22R-1C -R2
E209	23S75372W15	CAP,ELY 1R0-1H -R2
E210	23S75372W15	CAP,ELY 1R0-1H -R2
E211	23S75373W13	CAP,ELY 1R0-1H -R2
E212	23S75373W13	CAP,ELY 1R0-1H -R2
E213	23S75373W13	CAP,ELY 1R0-1H -R2
E214	23S75373W13	CAP,ELY 1R0-1H -R2
E215	23S75373W03	CAP,ELY 22R-1C -R2
E216	23S75372W04	CAP,ELY 10R-1C -R2
E217	23S75372W15	CAP,ELY 1R0-1H -R2
E218	23S75372W05	CAP,ELY 22R-1C -R2
E232	23S75372W16	CAP,ELY 2R2-1H -R2
E233	23S75372W16	CAP,ELY 2R2-1H -R2
E234	23S75372W16	CAP,ELY 2R2-1H -R2
E235	23S75372W16	CAP,ELY 2R2-1H -R2
E236	23S75372W16	CAP,ELY 2R2-1H -R2
E237	23S75372W16	CAP,ELY 2R2-1H -R2
E305	23S75372W04	CAP,ELY 10R-1C -R2
E306	23S75372W04	CAP,ELY 10R-1C -R2
E307	23S75372W04	CAP,ELY 10R-1C -R2
E308	23S75372W04	CAP,ELY 10R-1C -R2
E309	23S95415W14	CAP,ELY R22-1H -R2
E310	23S95415W03	CAP,ELY 10R-1C -R2
E311	23S95415W13	CAP,ELY R10-1H -R2
E312	23S95415W17	CAP,ELY 1R0-1H -R2
E313	23T75346W03	CAP,X-PRO 332-1C +
E601	23S75372W05	CAP,ELY 22R-1C -R2
E602	23S75372W03	CAP,ELY 221-1A -H2
E604	23S75373W02	CAP,ELY 10R-1C -R2
E651	23S75373W04	CAP,ELY 33R-1C -R2
E805	23S75372W15	CAP,ELY 1R0-1H -R2
E806	23S75372W03	CAP,ELY 221-1A -H2
E807	23S75373W04	CAP,ELY 33R-1C -R2
E808	23S75373W06	CAP,ELY 101-1C -R2
E809	23S75373W06	CAP,ELY 101-1C -R2
E810	23S75372W07	CAP,ELY 47R-1C -R2
E812	23S75372W04	CAP,ELY 10R-1C -R2
IC010	51T15132Y02	SAA6588T -SE9
IC011	51T25259Y01	BA00AST -IS
IC012	51T93333F01	NJM2904M-TE3 -SE2
IC013	51T15731W10	TC7S66F-TE85L -CP
IC101	51T15510W01	IC ,MC34063AML -SPD
IC201	51T15420Y01	BA4560F-E2 -SE2

IC202	51T65381Y01	TDA7412 -QT
IC203	51T15420Y01	BA4560F-E2 -SE2
IC302	51T55148Y01	TA8273H -ZS
IC601	51T65272Y01	IC,D784216AGF-532-QT
IC651	51T95193W01	TDA3606AT -SE9
IC652	51T65016Y19	S-80930CNMC-T2 -CP
L002	24T25164Y21	IND,FSLM2520 4R7J-CP
L003	24T16403W29	COI,IND.15R-M -CP
L004	24T35286Y01	IND,MG56 523J -DB
L005	24T25164Y21	IND,FSLM2520 4R7J-CP
L101	24T16271W13	COIL,RCR875D-221K
L600	24T65053W18	IND,LAL02VD 4R7K -R5
L602	24T65053W18	IND,LAL02VD 4R7K -R5
L603	25T01879K01	CHOKE,LAT1608-105-DB
PS001	48T95226W01	TMT,PTGL05BA1R8M1-R5
Q074	48T63420F01	TR,2SA1037AK-146 -CP
Q075	48T73888F13	TR ,CP FMC3-99
Q077	48T73888F13	TR ,CP FMC3-99
Q111	48T15511W02	CP.2SB1261-TE2 -E5
Q112	48T73888F12	TR ,CP.FMC2-99
Q201	48T62967F03	TR,DTC124EKA-T146-CP
Q202	48T62967F33	TR,DTC343TK-T146 -CP
Q203	48T62967F33	TR,DTC343TK-T146 -CP
Q204	48T62967F33	TR,DTC343TK-T146 -CP
Q205	48T62967F33	TR,DTC343TK-T146 -CP
Q206	48T62967F33	TR,DTC343TK-T146 -CP
Q207	48T62967F33	TR,DTC343TK-T146 -CP
Q300	48T62967F03	TR,DTC124EKA-T146-CP
Q601	48T62966F03	TR,DTA124EKA-T146-CP
Q603	48T64222F02	TR ,UN2212 22-22 -TX
Q604	48T73888F13	TR ,CP FMC3-99
Q605	48T62967F02	TR,DTC114EKA-T146-CP
Q606	48T63420F01	TR,2SA1037AK-146 -CP
Q610	48T62967F03	TR,DTC124EKA-T146-CP
Q611	48T62967F02	TR,DTC114EKA-T146-CP
Q612	48T62967F03	TR,DTC124EKA-T146-CP
Q651	48T73888F12	TR ,CP.FMC2-99
Q652	48T73888F12	TR ,CP.FMC2-99
Q664	48T62966F01	TR,DTA143EKA-T146-CP
Q800	48T69176F02	TR ,2SC3421-Y
Q801	48T84366F04	TR,2SB1243-QR-TV2-RD
Q802	48T84366F04	TR,2SB1243-QR-TV2-RD
Q804	48T73888F12	TR ,CP.FMC2-99
Q805	48T62967F05	TR,DTC143XKA-T146-CP
Q807	48T93828F04	TR,2SD1994A-S-TA -RD
Q809	48T62967F01	TR,DTC143EKA-T146-CP
Q810	48T62967F03	TR,DTC124EKA-T146-CP
Q866	48T73888F12	TR ,CP.FMC2-99
Q867	48T93828F04	TR,2SD1994A-S-TA -RD
R003	06S45675W43	RES,RK JUMPER1/10-CP

CDM-9825RB

R004	06S45675W43	RES,RK JUMPER1/10-CP
R005	06S45675W43	RES,RK JUMPER1/10-CP
R006	06S45675W43	RES,RK JUMPER1/10-CP
R013	06S45674W75	RES,RK 562J 1/10 -CP
R014	06S45674W75	RES,RK 562J 1/10 -CP
R015	06S45674W57	RES,RK 102J 1/10 -CP
R017	06S45674W69	RES,RK 332J 1/10 -CP
R018	06S45675W22	RES,RK 474J 1/10 -CP
R020	06S45674W73	RES,RK 472J 1/10 -CP
R021	06S45674W57	RES,RK 102J 1/10 -CP
R022	06S45675W43	RES,RK JUMPER1/10-CP
R023	06S45675W43	RES,RK JUMPER1/10-CP
R024	06S45675W43	RES,RK JUMPER1/10-CP
R025	06S45675W43	RES,RK JUMPER1/10-CP
R026	06S45675W43	RES,RK JUMPER1/10-CP
R027	06S45674W89	RES,RK 223J 1/10 -CP
R028	06S45674W57	RES,RK 102J 1/10 -CP
R029	06S45674W57	RES,RK 102J 1/10 -CP
R030	06S45674W57	RES,RK 102J 1/10 -CP
R031	06S15593Y76	RES,RK 133F 1/10 -CP
R032	06S45675W43	RES,RK JUMPER1/10-CP
R033	06S15593Y57	RES,RK 222F 1/10 -CP
R035	06S45674W57	RES,RK 102J 1/10 -CP
R036	06S45674W57	RES,RK 102J 1/10 -CP
R038	06S45674W49	RES,RK 471J 1/10 -CP
R039	06S45674W49	RES,RK 471J 1/10 -CP
R040	06S45674W57	RES,RK 102J 1/10 -CP
R041	06S45674W81	RES,RK 103J 1/10 -CP
R042	06S45674W81	RES,RK 103J 1/10 -CP
R043	06S45674W09	RES,RK 10RJ 1/10 -CP
R044	06S35095Y08	RES,RK JUMPER 1/4-CP
R046	06S45674W09	RES,RK 10RJ 1/10 -CP
R047	06S70072F05	RES,CP .10R-J-1/4-CP
R050	06S45674W57	RES,RK 102J 1/10 -CP
R103	06S70072F50	RES,CP .751-J-1/4-CP
R104	06S70072F50	RES,CP .751-J-1/4-CP
R105	06S70072F29	RES,CP .101-J-1/4-CP
R106	06S70072F47	RES,CP .561-J-1/4-CP
R107	06S70072F47	RES,CP .561-J-1/4-CP
R108	06S45675W02	RES,RK 683J 1/10 -CP
R109	06S35084Y41	RES,RK 223F 1/8 -CP
R110	06S35084Y33	RES,RK 472F 1/8 -CP
R200	06S45674W90	RES,RK 243J 1/10 -CP
R201	06S45674W58	RES,RK 112J 1/10 -CP
R202	06S45674W58	RES,RK 112J 1/10 -CP
R203	06S45674W58	RES,RK 112J 1/10 -CP
R204	06S45674W58	RES,RK 112J 1/10 -CP
R205	06S45674W77	RES,RK 682J 1/10 -CP
R206	06S45674W65	RES,RK 222J 1/10 -CP
R207	06S45674W95	RES,RK 393J 1/10 -CP

R208	06S45675W22	RES,RK 474J 1/10 -CP
R209	06S45674W57	RES,RK 102J 1/10 -CP
R210	06S45674W57	RES,RK 102J 1/10 -CP
R218	06S64996F39	RES,RK JUMPER 1/8-CP
R219	06S64996F39	RES,RK JUMPER 1/8-CP
R220	06S64996F39	RES,RK JUMPER 1/8-CP
R221	06S64996F39	RES,RK JUMPER 1/8-CP
R222	06S64996F39	RES,RK JUMPER 1/8-CP
R223	06S64996F39	RES,RK JUMPER 1/8-CP
R236	06S45674W33	RES,RK 101J 1/10 -CP
R237	06S45674W33	RES,RK 101J 1/10 -CP
R238	06S45674W33	RES,RK 101J 1/10 -CP
R239	06S45674W33	RES,RK 101J 1/10 -CP
R240	06S45674W33	RES,RK 101J 1/10 -CP
R241	06S45674W33	RES,RK 101J 1/10 -CP
R244	06S45674W97	RES,RK 473J 1/10 -CP
R245	06S45674W97	RES,RK 473J 1/10 -CP
R246	06S45674W97	RES,RK 473J 1/10 -CP
R247	06S45674W97	RES,RK 473J 1/10 -CP
R248	06S45674W97	RES,RK 473J 1/10 -CP
R249	06S45674W97	RES,RK 473J 1/10 -CP
R250	06S45674W33	RES,RK 101J 1/10 -CP
R251	06S45674W33	RES,RK 101J 1/10 -CP
R252	06S45674W33	RES,RK 101J 1/10 -CP
R253	06S45674W33	RES,RK 101J 1/10 -CP
R254	06S45674W33	RES,RK 101J 1/10 -CP
R255	06S45674W33	RES,RK 101J 1/10 -CP
R307	06S70072F77	RES,CP .103-J-1/4-CP
R308	06S45674W81	RES,RK 103J 1/10 -CP
R309	06S45675W43	RES,RK JUMPER1/10-CP
R600	06S45674W97	RES,RK 473J 1/10 -CP
R604	06S45674W89	RES,RK 223J 1/10 -CP
R605	06S45674W97	RES,RK 473J 1/10 -CP
R606	06S45674W57	RES,RK 102J 1/10 -CP
R607	06S45674W81	RES,RK 103J 1/10 -CP
R608	06S64995F77	RES,RK 103J 1/8 -CP
R609	06T45541Y01	RES,RS 12RJ 2W -
R611	06S70072F69	RES,CP .472-J-1/4-CP
R612	06S70072F29	RES,CP .101-J-1/4-CP
R613	06S45674W57	RES,RK 102J 1/10 -CP
R614	06S64995F53	RES,RK 102J 1/8 -CP
R615	06S64995F53	RES,RK 102J 1/8 -CP
R616	06S64995F53	RES,RK 102J 1/8 -CP
R617	06S45674W57	RES,RK 102J 1/10 -CP
R618	06S45675W43	RES,RK JUMPER1/10-CP
R619	06S45674W57	RES,RK 102J 1/10 -CP
R620	06S45674W57	RES,RK 102J 1/10 -CP
R621	06S64995F53	RES,RK 102J 1/8 -CP
R623	06S45674W57	RES,RK 102J 1/10 -CP
R624	06S45674W57	RES,RK 102J 1/10 -CP

CDM-9825RB

R625	06S45674W81	RES,RK 103J 1/10 -CP
R626	06S45674W81	RES,RK 103J 1/10 -CP
R628	06S45674W69	RES,RK 332J 1/10 -CP
R629	06S45674W97	RES,RK 473J 1/10 -CP
R630	06S45674W89	RES,RK 223J 1/10 -CP
R631	06S70072F98	RES,RK 223J 1/4 -CP
R632	06S70072F37	RES,CP .221-J-1/4-CP
R633	06S45674W65	RES,RK 222J 1/10 -CP
R634	06S45674W43	RES,RK 271J 1/10 -CP
R635	06S45674W97	RES,RK 473J 1/10 -CP
R636	06S35095Y03	RES,RK 473J 1/4 -CP
R638	06S45674W83	RES,RK 123J 1/10 -CP
R639	06S45675W43	RES,RK JUMPER1/10-CP
R640	06S45675W22	RES,RK 474J 1/10 -CP
R641	06S70072F98	RES,RK 223J 1/4 -CP
R642	06S45674W57	RES,RK 102J 1/10 -CP
R644	06S45674W97	RES,RK 473J 1/10 -CP
R645	06S45674W43	RES,RK 271J 1/10 -CP
R646	06S45674W73	RES,RK 472J 1/10 -CP
R647	06S45674W73	RES,RK 472J 1/10 -CP
R649	06S45674W89	RES,RK 223J 1/10 -CP
R650	06S45674W89	RES,RK 223J 1/10 -CP
R651	06S45674W99	RES,RK 563J 1/10 -CP
R654	06S70072F69	RES,CP .472-J-1/4-CP
R655	06S70072F69	RES,CP .472-J-1/4-CP
R656	06S64996F14	RES,RK 334J 1/8 -CP
R657	06S15593Y99	RES,RK 124F 1/10 -CP
R658	06S45675W06	RES,RK 104J 1/10 -CP
R659	06S70072F77	RES,CP .103-J-1/4-CP
R660	06S70072F77	RES,CP .103-J-1/4-CP
R662	06S45674W83	RES,RK 123J 1/10 -CP
R663	06S45674W89	RES,RK 223J 1/10 -CP
R664	06S35095Y03	RES,RK 473J 1/4 -CP
R666	06S45675W43	RES,RK JUMPER1/10-CP
R667	06S45675W43	RES,RK JUMPER1/10-CP
R668	06S45675W43	RES,RK JUMPER1/10-CP
R670	06S45674W89	RES,RK 223J 1/10 -CP
R671	06S45674W89	RES,RK 223J 1/10 -CP
R672	06S45674W57	RES,RK 102J 1/10 -CP
R673	06S45674W81	RES,RK 103J 1/10 -CP
R674	06S15593Y63	RES,RK 392F 1/10 -CP
R675	06S15593Y73	RES,RK 103F 1/10 -CP
R676	06S70072F63	RES,CP .272-J-1/4-CP
R681	06S64995F53	RES,RK 102J 1/8 -CP
R682	06S64995F53	RES,RK 102J 1/8 -CP
R683	06S45674W57	RES,RK 102J 1/10 -CP
R684	06S45674W57	RES,RK 102J 1/10 -CP
R685	06S45674W81	RES,RK 103J 1/10 -CP
R686	06S45674W65	RES,RK 222J 1/10 -CP
R800	06S70072F29	RES,CP .101-J-1/4-CP

R803	06S45675W06	RES,RK 104J 1/10 -CP
R808	06S70072F51	RES,CP .821-J-1/4-CP
R820	06S70072F77	RES,CP .103-J-1/4-CP
R821	06S55366Y33	RES,RK 624J 1/10 -CP
R822	06S70072F46	RES,CP .511-J-1/4-CP
R823	06S70072F58	RES,CF .162-J-1/4-CP
R824	06S70072F58	RES,CF .162-J-1/4-CP
R825	06S70072F57	RES,CP .152-J-1/4-CP
R826	06S35095Y15	RES,RK 243J 1/4 -CP
R827	06S70072F57	RES,CP .152-J-1/4-CP
R833	06S45674W90	RES,RK 243J 1/10 -CP
R834	06S70072F59	RES,CP .182-J-1/4-CP
R835	06S70072F59	RES,CP .182-J-1/4-CP
R836	06S70072F53	RES,CP .102-J-1/4-CP
R837	06S45674W81	RES,RK 103J 1/10 -CP
R838	06S45674W81	RES,RK 103J 1/10 -CP
R839	06S70072F77	RES,CP .103-J-1/4-CP
R880	06S45674W83	RES,RK 123J 1/10 -CP
R881	06S35095Y08	RES,RK JUMPER 1/4-CP
R882	06S55361Y57	RES,RK 471J 1/4 -CP
R883	06S45674W57	RES,RK 102J 1/10 -CP
SA002	48T81909F01	PTT,DSP-201M -A1
SD100	48T85269W01	DIO,SHT SB040 -A5
SD600	48T68580F03	DIO,SI DSA3A4-F5
SW601	40T16096W03	SW ,TACT SKHHLW, (RESET)
TH601	48T93439F06	TMT, 104 -R2
XL002	91T25806W18	XTL,4.332M -AT51-TP
XL601	91T55360Y03	XTL,AT-51 12.288M-R5
Z301	24T35072W03	FBI,BL02RN1R2P1A -R5
Z302	24T35072W03	FBI,BL02RN1R2P1A -R5
ZD652	48T83128F14	DIO,ZEN HZS 7B2L -A5
ZD800	48T83128F25	DIO,ZEN.HZS 9C1L -A5
ZD803	48T83128F26	DIO,ZEN.HZS 9C2L -A5
ZD804	48T25766W25	DIO,ZEN.HZS 9C2L -R5
=====FRONT P.W.Board		
C404	08S45677W58	CAP,CER 821J-CH1H-CP
C405	08S45676W89	CAP,CER 473K-B1E -CP
C406	08S45676W89	CAP,CER 473K-B1E -CP
C407	08S45676W89	CAP,CER 473K-B1E -CP
C409	08S45676W80	CAP,CER 223K-B1E -CP
C410	08S45676W80	CAP,CER 223K-B1E -CP
D401	48T85357W01	DIO,1PS226 -CP
D402	48T85357W01	DIO,1PS226 -CP
D403	48T85357W01	DIO,1PS226 -CP
D404	48T85357W01	DIO,1PS226 -CP
D405	48T85357W01	DIO,1PS226 -CP
D415	48T81063F01	DIO,CP.MA159 / TX-CP
D416	48T81063F01	DIO,CP.MA159 / TX-CP
D417	48T81063F01	DIO,CP.MA159 / TX-CP

CDM-9825RB

IC401	51T02347K01	PT6583LQ -QT
LD451	48T65176Y02	LED,BLU DB1111C -CP
LD452	48T25534Y01	LED,GRN BG1111C -CP
LD453	48T25534Y01	LED,GRN BG1111C -CP
LD455	48T25534Y01	LED,GRN BG1111C -CP
LD456	48T25534Y01	LED,GRN BG1111C -CP
LD458	48T25534Y01	LED,GRN BG1111C -CP
LD459	48T25534Y01	LED,GRN BG1111C -CP
LD461	48T65708Y01	LED,WHT UW1149B -E1
LD462	48T65708Y01	LED,WHT UW1149B -E1
LD463	48T65176Y02	LED,BLU DB1111C -CP
LD464	48T25534Y01	LED,GRN BG1111C -CP
LD465	48T25534Y01	LED,GRN BG1111C -CP
LD466	48T25534Y01	LED,GRN BG1111C -CP
LD467	48T25534Y01	LED,GRN BG1111C -CP
LD469	48T25534Y01	LED,GRN BG1111C -CP
LD470	48T25534Y01	LED,GRN BG1111C -CP
LD471	48T25534Y01	LED,GRN BG1111C -CP
LD472	48T25534Y01	LED,GRN BG1111C -CP
LD473	48T25534Y01	LED,GRN BG1111C -CP
LD474	48T25534Y01	LED,GRN BG1111C -CP
LD478	48T65708Y01	LED,WHT UW1149B -E1
LD479	48T65708Y01	LED,WHT UW1149B -E1
LD480	48T65176Y02	LED,BLU DB1111C -CP
LD481	48T65176Y02	LED,BLU DB1111C -CP
LD482	48T25534Y03	LED,AMB AA1111C -CP
Q451	48T63788F04	TR ,CP.2SD1328-T -TX
R401	06S64995F86	RES,RK 243J 1/8 -CP
R402	06S45674W57	RES,RK 102J 1/10 -CP
R403	06S45674W57	RES,RK 102J 1/10 -CP
R404	06S45674W57	RES,RK 102J 1/10 -CP
R405	06S45674W57	RES,RK 102J 1/10 -CP
R406	06S45674W57	RES,RK 102J 1/10 -CP
R407	06S45674W97	RES,RK 473J 1/10 -CP
R409	06S64995F77	RES,RK 103J 1/8 -CP
R410	06S64995F77	RES,RK 103J 1/8 -CP
R411	06S64995F77	RES,RK 103J 1/8 -CP
R412	06S64995F53	RES,RK 102J 1/8 -CP
R413	06S64995F77	RES,RK 103J 1/8 -CP
R414	06S64995F86	RES,RK 243J 1/8 -CP
R419	06S45674W73	RES,RK 472J 1/10 -CP
R420	06S45675W06	RES,RK 104J 1/10 -CP
R421	06S45674W57	RES,RK 102J 1/10 -CP
R422	06S45674W57	RES,RK 102J 1/10 -CP
R423	06S45674W57	RES,RK 102J 1/10 -CP
R424	06S45674W57	RES,RK 102J 1/10 -CP
R425	06S45674W57	RES,RK 102J 1/10 -CP
R426	06S45674W57	RES,RK 102J 1/10 -CP
R427	06S45674W57	RES,RK 102J 1/10 -CP
R428	06S45674W57	RES,RK 102J 1/10 -CP

R429	06S45674W57	RES,RK 102J 1/10 -CP
R430	06S45674W57	RES,RK 102J 1/10 -CP
R451	06S70072F49	RES,CP .681-J-1/4-CP
R452	06S70072F49	RES,CP .681-J-1/4-CP
R455	06S70072F36	RES,CP .201-J-1/4-CP
R456	06S70072F37	RES,CP .221-J-1/4-CP
R457	06S70072F37	RES,CP .221-J-1/4-CP
R458	06S70072F37	RES,CP .221-J-1/4-CP
R461	06S70072F36	RES,CP .201-J-1/4-CP
R462	06S70072F37	RES,CP .221-J-1/4-CP
R463	06S70072F36	RES,CP .201-J-1/4-CP
R464	06S70072F37	RES,CP .221-J-1/4-CP
R465	06S70072F39	RES,CP .271-J-1/4-CP
R466	06S70072F41	RES,CP .331-J-1/4-CP
R467	06S70072F41	RES,CP .331-J-1/4-CP
R468	06S70072F41	RES,CP .331-J-1/4-CP
R469	06S70072F41	RES,CP .331-J-1/4-CP
R472	06S70072F23	RES,CP .56R-J-1/4-CP
R473	06S70072F23	RES,CP .56R-J-1/4-CP
R474	06S70072F31	RES,CP .121-J-1/4-CP
R475	06S70072F31	RES,CP .121-J-1/4-CP
R476	06S64995F55	RES,RK 122J 1/8 -CP
R477	06S70072F35	RES,CP .181-J-1/4-CP
R480	06S70072F49	RES,CP .681-J-1/4-CP
R481	06S70072F49	RES,CP .681-J-1/4-CP
R482	06S70072F39	RES,CP .271-J-1/4-CP
R483	06S70072F41	RES,CP .331-J-1/4-CP
R484	06S70072F41	RES,CP .331-J-1/4-CP
R487	06S70072F34	RES,CP .161-J-1/4-CP
SW401	40T65353Y01	SW,TACT SKRSPACE010E2 (FWD/UP)
SW402	40T65353Y01	SW,TACT SKRSPACE010E2 (BWD/DN)
SW404	40T65353Y01	SW,TACT SKRSPACE010E2 (5/M.I.X.)
SW405	40T65353Y01	SW,TACT SKRSPACE010E2 (SOURCE/POWER)
SW406	40T65353Y01	SW,TACT SKRSPACE010E2 (1/AF)
SW407	40T65353Y01	SW,TACT SKRSPACE010E2 (6/SCAN)
SW408	40T65353Y01	SW,TACT SKRSPACE010E2 (PLAY/PAUSE/TUNE/A.ME)
SW410	40T65353Y01	SW,TACT SKRSPACE010E2 (2/NEWS)
SW411	40T65353Y01	SW,TACT SKRSPACE010E2 (F/SETUP)
SW412	40T65353Y01	SW,TACT SKRSPACE010E2 (T.INFO)
SW413	40T65353Y01	SW,TACT SKRSPACE010E2 (3/PTY)
SW414	40T65353Y01	SW,TACT SKRSPACE010E2 (MUTE)

CDM-9825RB

SW416	40T65353Y01	SW,TACT SKRSPACE010E2 (BAND)
SW418	40T65353Y01	SW,TACT SKRSPACE010E2 (4/REPEAT)
SW419	40T65353Y01	SW,TACT SKRSPACE010E2 (EJECT)
SW420	40T65353Y01	SW,TACT SKRSPACE010E2 (DISP)
SW422	40T65353Y01	SW,TACT SKRSPACE010E2 (CENTERf)
ZD401	48T62934F26	DIO,ZEN.RD6.2MB3 -CP
ZD451	48T15541Y23	DIO,ZEN MAZS180 -CP
ZD452	48T15541Y23	DIO,ZEN MAZS180 -CP
=====DP-S MAIN P.W.Board		
C238	08S45676W85	CAP,CER 104K-B1C -CP
C240	08S45676W85	CAP,CER 104K-B1C -CP
C241	08S45676W73	CAP,CER.103K-B1H -CP
C246	08S45676W85	CAP,CER 104K-B1C -CP
C302	08S45676W85	CAP,CER 104K-B1C -CP
C304	08S45676W80	CAP,CER 223K-B1E -CP
C305	08S45676W85	CAP,CER 104K-B1C -CP
C306	08S45676W85	CAP,CER 104K-B1C -CP
C308	08S45676W85	CAP,CER 104K-B1C -CP
C310	08S45676W85	CAP,CER 104K-B1C -CP
C311	08S45676W73	CAP,CER.103K-B1H -CP
C314	08S45676W65	CAP,CER.222K-B1H -CP
C315	08S45676W65	CAP,CER.222K-B1H -CP
C318	08S45676W73	CAP,CER.103K-B1H -CP
C319	08S45676W85	CAP,CER 104K-B1C -CP
C320	08S45676W85	CAP,CER 104K-B1C -CP
C321	08S45676W85	CAP,CER 104K-B1C -CP
C322	08S45676W87	CAP,CER 333K-B1E -CP
C323	08S45676W85	CAP,CER 104K-B1C -CP
C324	08S45676W85	CAP,CER 104K-B1C -CP
C325	08S45676W68	CAP,CER.392K-B1H -CP
C326	08S45676W93	CAP,CER 224K-B1A -CP
C327	08S45677W20	CAP,CER.22RJ-CH1H-CP
C328	08S45677W03	CAP,CER 1R5C-CH1H-CP
C330	08S45677W30	CAP,CER.56RJ-CH1H-CP
C331	08S45677W26	CAP,CER.39RJ-CH1H-CP
C332	08S45676W85	CAP,CER 104K-B1C -CP
C334	08S45676W85	CAP,CER 104K-B1C -CP
C336	08S45676W85	CAP,CER 104K-B1C -CP
C341	08S45677W20	CAP,CER.22RJ-CH1H-CP
C345	08S45677W60	CAP,CER 102J-CH1H-CP
C346	08S45677W60	CAP,CER 102J-CH1H-CP
C409	08S45676W85	CAP,CER 104K-B1C -CP
C449	08S45677W40	CAP,CER.151J-CH1H-CP
C450	08S45677W54	CAP,CER 561J-CH1H-CP
CB101	09T45435W22	FFC,52207-2290 -EQ
CB102	09T45435W15	FFC,52207-1590 -ED

CB103	09T45435W07	FFC,52207-0790 -E9
CL201	91T45281Y03	OSC,CER CSTCR4M19-E1
CL301	91T55147Y01	OSC,CER CSACV16M9-E1
D401	48T81063F01	DIO,CP.MA159 / TX-CP
E239	23T45152Y02	CAP,RA 47R-05 -E5
E301	23T45152Y02	CAP,RA 47R-05 -E5
E303	23S55311W35	CAP,TAN 10R-1C-B -CP
E310	23S55311W35	CAP,TAN 10R-1C-B -CP
E316	23T45152Y02	CAP,RA 47R-05 -E5
E317	23T45152Y03	CAP,RA 22R-OJ -E5
E329	23S55311W28	CAP,TAN 22R-1A-B -CP
E331	23S55311W31	CAP,TAN.2R2-1C-A -CP
E333	23T45152Y04	CAP,RA 10R-1C -E5
E337	23T45152Y02	CAP,RA 47R-05 -E5
E338	23S55311W35	CAP,TAN 10R-1C-B -CP
E407	23T45152Y04	CAP,RA 10R-1C -E5
IC201	51T55329Y02	IC,D789026GB-A82 -QT
IC301	51T55156Y01	UPD63711A -QT
IC302	51T55295Y01	AN80M50RSPE1 -NE5
IC401	51T55093Y01	BA5984FP-E2 -SEA
Q301	48T55462Y01	TR,2SB1132-QR-100-E2
Q401	48T94606F03	TR,DTC124EUA-T106-CP
R201	06S45674W97	RES,RK 473J 1/10 -CP
R202	06S45674W97	RES,RK 473J 1/10 -CP
R203	06S45674W97	RES,RK 473J 1/10 -CP
R212	06S45674W33	RES,RK 101J 1/10 -CP
R226	06S45674W93	RES,RK 333J 1/10 -CP
R228	06S45674W81	RES,RK 103J 1/10 -CP
R229	06S45674W97	RES,RK 473J 1/10 -CP
R230	06S45674W33	RES,RK 101J 1/10 -CP
R246	06S45675W43	RES,RK JUMPER1/10-CP
R250	06S45674W97	RES,RK 473J 1/10 -CP
R251	06S45674W97	RES,RK 473J 1/10 -CP
R252	06S45674W97	RES,RK 473J 1/10 -CP
R253	06S45674W97	RES,RK 473J 1/10 -CP
R254	06S45674W97	RES,RK 473J 1/10 -CP
R255	06S45674W97	RES,RK 473J 1/10 -CP
R256	06S45674W97	RES,RK 473J 1/10 -CP
R257	06S45674W97	RES,RK 473J 1/10 -CP
R258	06S45674W97	RES,RK 473J 1/10 -CP
R259	06S45674W97	RES,RK 473J 1/10 -CP
R260	06S45674W97	RES,RK 473J 1/10 -CP
R261	06S45674W97	RES,RK 473J 1/10 -CP
R262	06S45674W97	RES,RK 473J 1/10 -CP
R263	06S45674W97	RES,RK 473J 1/10 -CP
R264	06S45674W97	RES,RK 473J 1/10 -CP
R265	06S45674W97	RES,RK 473J 1/10 -CP
R266	06S45674W97	RES,RK 473J 1/10 -CP
R270	06S45674W93	RES,RK 333J 1/10 -CP
R301	06S70072F05	RES,CP .10R-J-1/4-CP

CDM-9825RB

R302	06S70072F05	RES,CP .10R-J-1/4-CP
R311	06S45675W43	RES,RK JUMPER1/10-CP
R316	06S45674W41	RES,RK 221J 1/10 -CP
R317	06S45674W41	RES,RK 221J 1/10 -CP
R323	06S45674W81	RES,RK 103J 1/10 -CP
R324	06S45674W95	RES,RK 393J 1/10 -CP
R325	06S45674W78	RES,RK 752J 1/10 -CP
R331	06S45675W43	RES,RK JUMPER1/10-CP
R332	06S45675W43	RES,RK JUMPER1/10-CP
R333	06S45675W43	RES,RK JUMPER1/10-CP
R334	06S45675W43	RES,RK JUMPER1/10-CP
R341	06S45675W43	RES,RK JUMPER1/10-CP
R343	06S45674W93	RES,RK 333J 1/10 -CP
R344	06S45674W93	RES,RK 333J 1/10 -CP
R345	06S45674W93	RES,RK 333J 1/10 -CP
R401	06S45675W06	RES,RK 104J 1/10 -CP
R402	06S45674W33	RES,RK 101J 1/10 -CP
R403	06S64995F87	RES,RK 273J 1/8 -CP
R404	06S45674W95	RES,RK 393J 1/10 -CP
R405	06S45674W85	RES,RK 153J 1/10 -CP
R406	06S45674W81	RES,RK 103J 1/10 -CP
R407	06S45674W81	RES,RK 103J 1/10 -CP
R408	06S45674W89	RES,RK 223J 1/10 -CP
R409	06S45674W81	RES,RK 103J 1/10 -CP
R410	06S45674W81	RES,RK 103J 1/10 -CP
R411	06S45674W89	RES,RK 223J 1/10 -CP
R434	06S45674W33	RES,RK 101J 1/10 -CP
R435	06S45674W33	RES,RK 101J 1/10 -CP
R436	06S45674W33	RES,RK 101J 1/10 -CP
R437	06S45674W33	RES,RK 101J 1/10 -CP
RA201	06S45591W07	RES,ARY MNR101J 4-CP
RA202	06S45591W07	RES,ARY MNR101J 4-CP
=====Miscellaneous		
ANT001	01T03151K01	ASSY,ANT CABLE ISO
CB601	09T65330Y15	BTB,TMD-V15X-A1 -DB
CB801	09T35343Y16	WTB,IMSA9451B-16 -DB
CH401	09T15298Y15	BTB,TMD-V15P-A1 -B
DIN001	09T55493W02	DIN,SKT 8P CMS-R -DT
JK601	09T03156K01	JAC,CK-3.5-14-DB (ST-REMO)
SW421	40T75257Y01	ENC,EC11E1564411 -DB (ROTARY ENCODER/MODE/ LOUD)
RCA201	01T35497Y32	ASSY,WIRE RCA 9805R (SUB-W)
JK201	01T02234K03	ASSY,CONN NLT1661 (F/R)
M802	59T55190Y03	MOTOR,F2510CT-12UCV (FAN MOTOR/12V-40mA)
LCD401	65T65153Y04	LCD,WTD-21544AEHU

=====DP23S2AO		
HD101	81B50360Y01	PICKUP,EP21A67L
M101	01V56100Y14	ASSY,MOTOR WORM 2BO (3.5V-80mA)
M102	01V56100Y12	ASSY,MOTOR SLED 2BO (3.5V-80mA)
M103	01V56100Y11	ASSY,MTR SPINDOL 2BO (3V-90mA)
SW1	40T15494Y01	SW,DETCT SPVG23-E6 (12cm DISC DETECT (EJECT POSITION/ RELOAD))
SW2	40T15494Y02	SW,DETCT SPVG13-E6 8cm DISC DETECT (INSERT/PULL OUT))
SW3	40T15494Y07	SW,DETCT SPVG21-E6 (8cm DISC DETECT (EJECT POSITION/ RELOAD))
SW4	40T15494Y01	SW,DETCT SPVG23-E6 (DISC CHUCKING END DETECT)
SW105	40T71025F03	SW,DETCT SPPB120 (LIMIT)